

**CNP** 南方泵业



**NISO, NIS, NISF**

**50Hz**

**端吸离心泵**



股票代码：300145

**南方泵业股份有限公司**  
NANFANG PUMP INDUSTRY CO.,LTD.

公司地址：中国·杭州  
服务热线：400-826-7722  
电子邮箱：service@nanfang-pump.com  
网址 (WEB)：www.cnppump.com



编号：161212  
编码：150008150

数据仅供参考：如有修改，恕不通知。

版权所有，盗版必究！

**南方泵业股份有限公司**  
NANFANG PUMP INDUSTRY CO.,LTD.

南方泵业股份有限公司（以下简称南方泵业）创建于1991年，2010年12月9日在深圳交易所发行上市，股票简称：“南方泵业”，股票代码：“300145”。

南方泵业系全国最早研发并规模化生产不锈钢冲压焊接离心泵企业，是目前国内不锈钢冲压焊接离心泵领域产销量最大的专业生产厂家，并在湖南设立了大泵的生产基地。产品的系列范围、销售总量、产品质量均排在国内同行业首位。也是行业内率先研制、生产、销售管网叠压成套设备的企业。公司建立了完善的营销服务网络，在不断满足国内市场需求的同时积极出口海外市场，产品广泛应用于增压、工业、生活供水、空调水循环、供暖、消防系统、地下水抽取、污水废水处理、化工行业和海水淡化等诸多领域。

主导产品有：CDL、CDLF系列不锈钢轻型立式多级离心泵；CHL、CHLF、CHLFT系列不锈钢轻型卧式多级离心泵；DRL恒压变频供水设备，NFWG无负压变频供水设备。CHLF系列轻型卧式多级离心泵，CHLK系列空调专用泵，WQ系列污水污物潜水电泵，SJ系列不锈钢多级深井潜水电泵，QY系列自吸式气液混合泵，CDLK系列浸入式多级离心泵，TD系列管道循环泵，MS系列轻型不锈钢卧式单级离心泵，NISO,NIS,NISF系列端吸离心泵、ZS系列不锈钢卧式单级离心泵，SWB系列不锈钢卧式单级离心泵，SP系列无堵塞自吸式排污泵，VMHP系列海水淡化高压泵，NSC单级双吸中开式离心泵，NDS卧式中开多级离心泵，VTP立式长轴透平泵等系列产品，性能指标均处于国内领先水平。

如今南方泵业已步入高速发展的轨道，在“打造中国泵业强企和世界泵业知名品牌”的康庄大道上迈出了跨越性的一步。并为更好的满足客户需要和业务拓展需求，在全国建立了广泛的销售与服务网络，在全国各大中城市均设有直属办事处及服务中心，旨为客户提供最为及时、满意的服务；同时，公司产品已成功进军国际市场，同欧美、东南亚等60多个国家和地区的客户均建立了良好的业务往来关系。

以此为契机，南方泵业秉承“诚信共赢 超越自我”，“尧有道 创无限”的企业理念，充分满足客户和市场需求，为实现“绿色水力专家”而不懈努力！



中国节能认证



国家火炬计划重点高新技术企业



中国国家强制性产品认证证书



CE认证



中国船级社认证



矿用产品安全标志证书



安全生产标准化证书



中国质量认证



环境管理体系认证



职业健康安全管理体系认证



质量管理体系认证



测量管理体系认证



标准化良好行为证书



国际标准认证



中国环境标志（II型）产品认证证书

.....

NISO,NIS,NISF

总体数据

型号含义	4
最小进口压力	4
典型应用	4
泵结构	4
性能参数	4
曲线条件	4
特点	4
型谱图	5
截面图	6
零件材料	7
产品范围	8

技术数据

2极	
50-32-160/50-32-200	13
65-40-200/65-40-250	14
65-40-315/65-50-160	15
80-50-200/80-50-250	16
80-50-315/80-65-160	17
100-65-200/100-65-250	18
100-65-315/100-80-160	19
125-100-200/125-100-250	20
125-100-315	21
4极	
50-32-160	21
50-32-200/65-40-200	22
65-40-250/65-40-315	23
65-50-160/80-50-200	24
80-50-250/80-50-315	25
80-65-160/100-65-200	26
100-65-250/100-65-315	27
100-80-160/125-100-200	28
125-100-250/125-100-315	29
125-80-400/125-100-400	30
150-125-250/150-125-315	31
150-125-400/200-150-315	32
200-150-400/250-200-315	33
250-200-400/300-250-315(Q)	34
300-250-400(Q)/300-250-315	35
300-250-400	36
NISO泵外形尺寸图	37
NISO泵外形尺寸表	38
NISO泵组外形尺寸图	40
NISO泵组外形尺寸表	40
NIS,NISF泵外形尺寸图	45
NIS,NISF泵外形尺寸表	45
NIS,NISF法兰	50

NIS\*\*\*-\*\*\*G

总体数据

型号含义 ..... 51

最小进口压力 ..... 51

典型应用 ..... 51

泵结构 ..... 51

性能参数 ..... 51

曲线条件 ..... 51

特点 ..... 51

型谱图 ..... 52

产品范围 ..... 53

技术数据

2极

NIS100-65-200G ..... 55

NIS100-65-250G ..... 55

NIS100-65-315G ..... 56

NIS100-80-160G ..... 56

NIS125-100-200G ..... 57

NIS125-100-250G ..... 57

NIS125-100-315G ..... 58

4极

NIS100-65-200G ..... 58

NIS100-65-250G ..... 59

NIS100-65-315G ..... 59

NIS100-80-160G ..... 60

NIS125-100-200G ..... 60

NIS125-100-250G ..... 61

NIS125-100-315G ..... 61

NIS125-100-400G ..... 62

NIS150-125-200G ..... 62

NIS150-125-250G ..... 63

NIS150-125-315G ..... 63

NIS150-125-200G ..... 64

NIS200-150-250G ..... 64

NIS200-150-315G ..... 65

NIS200-150-400G ..... 65

型号含义

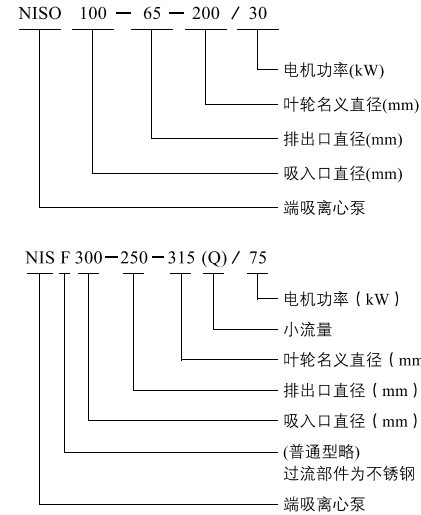

最小进口压力

- 最小进口压力取决于NPSH值+0.5m的安全余量+汽化压力。如果下列情况发生，重新计算入口压力：
- 液体温度较高
  - 流量超过最大允许使用时
  - 吸程较大或进口管路较长
  - 系统压力太小
  - 进口条件差、工作压力低

典型应用

- 产品适宜在清洁、稀薄、非侵蚀、非易燃易爆且不含固体颗粒或纤维的液体中使用。
- 供水系统
- 供热、空调系统
- 增压供水、恒压供水
- 消防、喷淋系统
- 灌溉、畜牧使用
- 工业冷却、加热循环系统
- 工业输送、排放系统

泵结构

- 泵为非自吸、单级单吸卧式，轴向进水，径向出水，泵体底部与底座固定。
- 采用标准型耐磨机械密封。
- 全封闭、风冷IEC标准电机
- NISO采用轴承架，可进行轴承定位，避免轴承的轴向窜动，同时提高了转子部件的刚性。
- NISO整体式泵轴，采用油脂润滑的导向深沟球轴承。
- NISO泵与电机之间采用半弹性联轴器相连。
- NISO泵外形及安装尺寸符合ISO 2858标准。
- NIS, NISF泵采用直联型联接加长轴结构。
- 铸铁泵体进出口法兰符合GB/T17241.6(ISO7005-2)标准，压力等级PN16；不锈钢泵体进出口法兰符合GB/T9113(ISO7005-1)标准，压力等级PN16。

性能参数

- 最大流量：1200m<sup>3</sup>/h
- 最高扬程：160m
- 最大工作压力：16bar
- 最大进口压力：6bar
- 最大功率：200kW
- 介质温度：-15℃~110℃
- 进出口径：进口口径：DN50~DN300  
出口口径：DN32~DN250

曲线条件

- 下列说明适用于后面所示的曲线。
- 曲线容差符合ISO9906:2012,3B。
  - 所有曲线都基于电机在恒速2900rpm、2950rpm、1450rpm或1480rpm的测量值。
  - 测试采用20℃不含空气的水，运动粘度为1mm<sup>2</sup>/s。

特点

- 采用后拉式结构，维修时无须拆除泵体及管路。
- NISO泵型仅采用4种泵轴及悬架体部件，提高了零件的互换性。
- 叶轮进行了优化设计，进口口径加大，无涡流，有效地降低水泵汽蚀余量，使得水泵运行平稳低噪声。
- NIS, NISF泵体积小、结构紧凑、安装简单。

型谱图

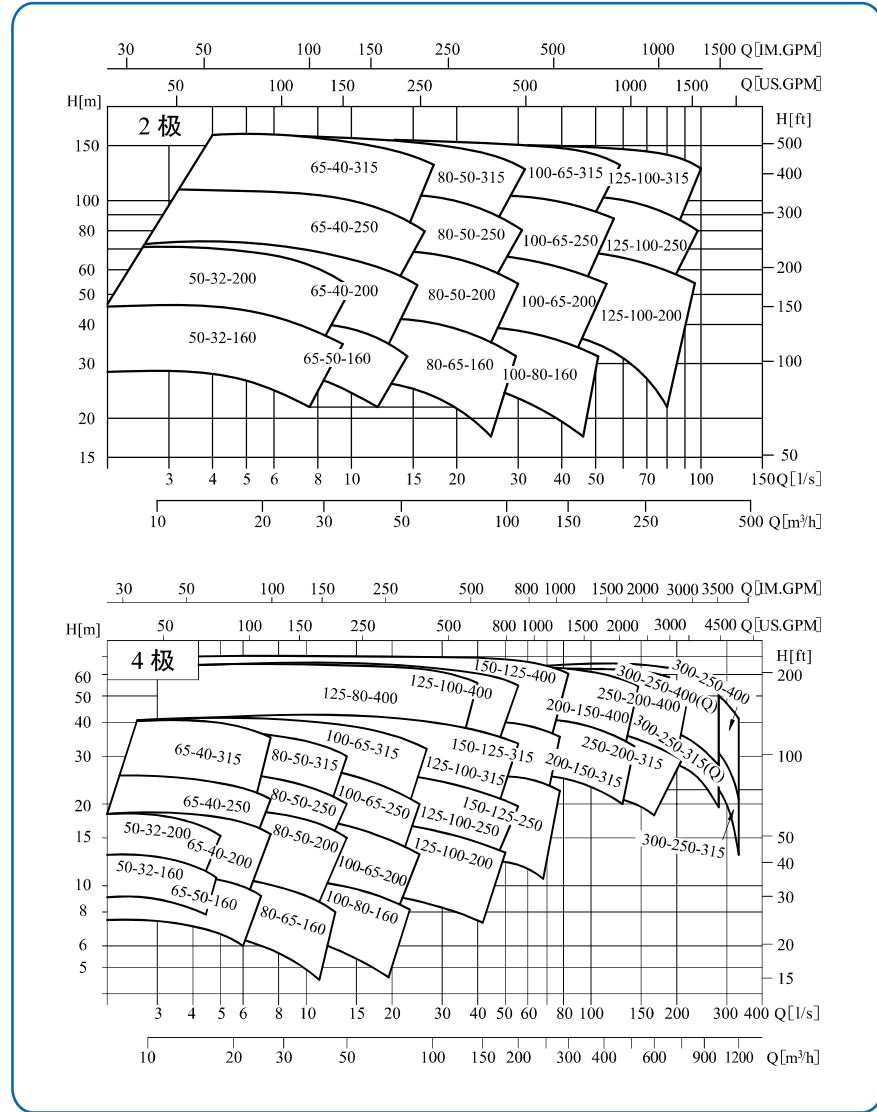

NISO截面图

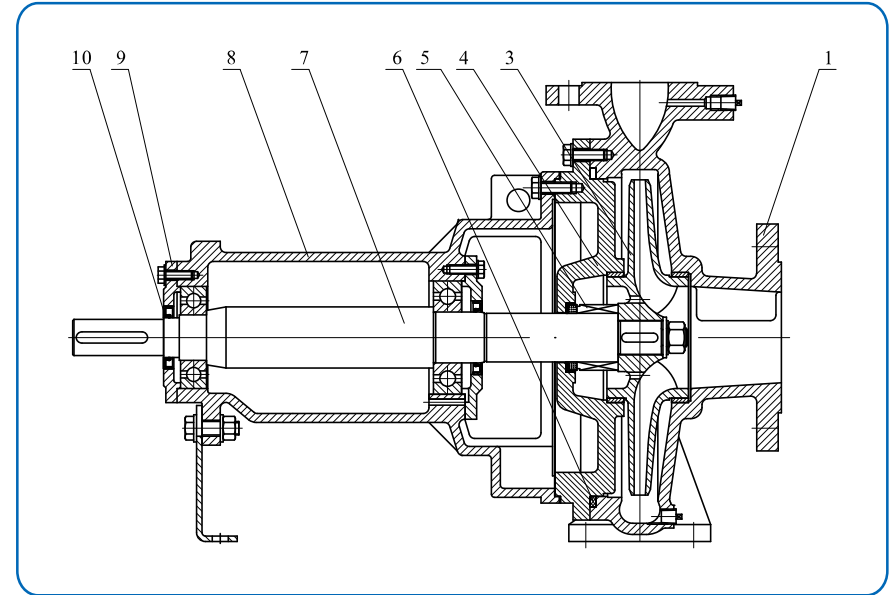

NISO零件材料

序号	零件名称	材料	对照代号 / AISI/ASTM
1	泵体	铸铁QT500-7/ZG07Cr19Ni9	ASTM80-55-06/AISI304
3	叶轮	铸铁HT200/ZG07Cr19Ni9	ASTM25B/AISI304
4	泵盖	铸铁HT200/ZG07Cr19Ni9	ASTM25B/AISI304
5	机械密封	石墨-碳化硅	
6	O形橡胶圈	丁腈橡胶NBR	
7	泵轴	不锈钢20Cr13/06Cr19Ni10	AISI420/AISI304
8	悬架体	铸铁HT200	ASTM25B
9	轴承压盖	铸铁HT200	ASTM25B
10	油封	丁腈橡胶NBR	



NIS, NISF截面图

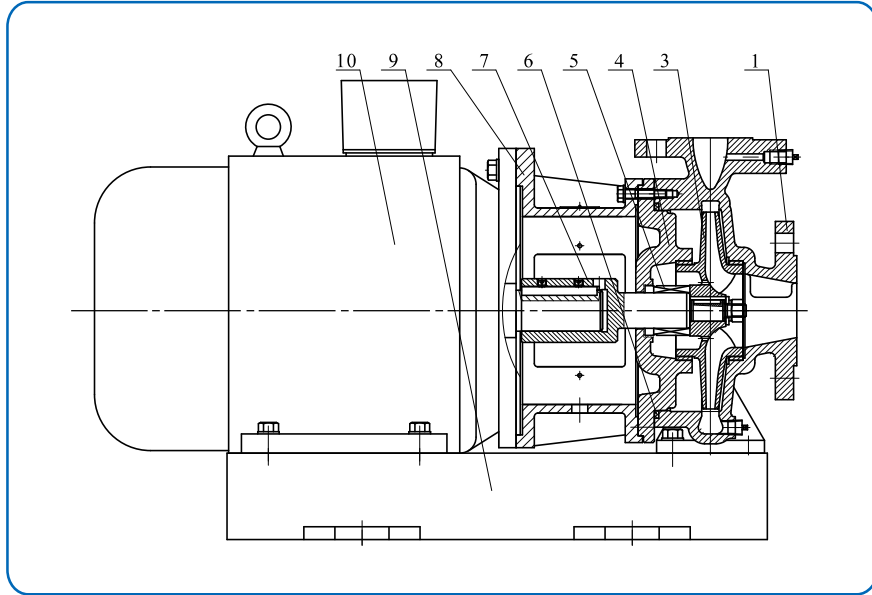

NIS, NISF零件材料

序号	零件名称	材料	对照代号 / AISI/ASTM
1	泵体	铸铁QT500-7/ZG07Cr19Ni9	ASTM80-55-06/AISI304
3	叶轮	铸铁HT 200/ZG07Cr19Ni9	ASTM25B/AISI304
4	泵盖	铸铁HT 200/ZG07Cr19Ni9	ASTM25B/AISI304
5	机械密封	石墨-碳化硅	
6	O形橡胶圈	丁腈橡胶NBR	
7	泵轴	不锈钢20Cr13/06Cr19Ni10	AISI420/AISI304
8	泵头	铸铁HT 200	ASTM25B
9	底座	Q235-A	AISA570
10	电机		

产品范围

2 极

序号	泵型号	Q [m <sup>3</sup> /h]	H [m]	配用电机 [kW]	n [r/min]
1	50-32-160/3	12.5	28	3	2900
2	50-32-160/4		36	4	
3	50-32-160/5.5		44	5.5	
4	50-32-200/7.5		55	7.5	
5	50-32-200/11		74	11	2950
6	65-40-200/7.5	25	48	7.5	2900
7	65-40-200/11		62	11	2950
8	65-40-200/15		72	15	
9	65-40-250/18.5		84	18.5	
10	65-40-250/22		95	22	
11	65-40-250/30		105	30	
12	65-40-315/22		105	22	
13	65-40-315/30		120	30	
14	65-40-315/37		145	37	
15	65-40-315/45		165	45	
16	65-50-160/4	50	28	4	
17	65-50-160/5.5		36	5.5	
18	65-50-160/7.5		42	7.5	
19	80-50-200/11		44	11	2950
20	80-50-200/15	57	15		
21	80-50-200/18.5	64	18.5		
22	80-50-200/22	71	22		
23	80-50-250/30	84	30		
24	80-50-250/37	100	37		
25	80-50-315/37	105	37		
26	80-50-315/45	125	45		
27	80-50-315/55	140	55		
28	80-50-315/75	152	75		

产品范围

2 极

序号	泵型号	Q [m³/h]	H [m]	配用电机 [kW]	n [r/min]
29	80-65-160/5.5	50	22	5.5	2900
30	80-65-160/7.5		29	7.5	
31	80-65-160/11		38	11	2950
32	80-65-160/15		44	15	
33	100-65-200/18.5	100	36	18.5	2950
34	100-65-200/22		43	22	
35	100-65-200/30		56	30	
36	100-65-200/37		67	37	
37	100-65-250/45		80	45	
38	100-65-250/55		88	55	
39	100-65-250/75		108	75	
40	100-65-315/90		128	90	
41	100-65-315/110		148	110	
42	100-80-160/11		23	11	
43	100-80-160/15		30	15	
44	100-80-160/18.5		35	18.5	
45	100-80-160/22	40	22		
46	125-100-200/30	200	34	30	2950
47	125-100-200/37		41	37	
48	125-100-200/45		48	45	
49	125-100-200/55		55	55	
50	125-100-200/75		66	75	
51	125-100-250/75		75	75	
52	125-100-250/90		86	90	
53	125-100-250/110		100	110	
54	125-100-315/90		93	90	
55	125-100-315/110		108	110	
56	125-100-315/132		124	132	
57	125-100-315/160	144	160		

产品范围

4 极

序号	泵型号	Q [m³/h]	H [m]	配用电机 [kW]	n [r/min]
1	50-32-160/0.55	6.3	8.5	0.55	1450
2	50-32-160/0.75		11	0.75	
3	50-32-200/1.1		14	1.1	
4	50-32-200/1.5		18	1.5	
5	65-40-200/1.1	12.5	12	1.1	
6	65-40-200/1.5		15	1.5	
7	65-40-200/2.2		17.5	2.2	
8	65-40-250/3		25	3	
9	65-40-315/4		34	4	
10	65-40-315/5.5		40	5.5	
11	65-50-160/0.55		7	0.55	
12	65-50-160/0.75		9	0.75	
13	65-50-160/1.1	10.5	1.1		
14	80-50-200/1.5	25	11	1.5	
15	80-50-200/2.2		15	2.2	
16	80-50-200/3		17.5	3	
17	80-50-250/4		21	4	
18	80-50-250/5.5		25	5.5	
19	80-50-315/5.5		30	5.5	
20	80-50-315/7.5		37	7.5	
21	80-65-160/0.75		6	0.75	
22	80-65-160/1.1		8	1.1	
23	80-65-160/1.5		10.5	1.5	
24	100-65-200/3		50	11.5	3
25	100-65-200/4	14		4	
26	100-65-200/5.5	16		5.5	
27	100-65-250/5.5	20		5.5	
28	100-65-250/7.5	25		7.5	
29	100-65-315/11	32		11	
30	100-65-315/15	40		15	
31	100-80-160/1.5	6.5		1.5	
32	100-80-160/2.2	9		2.2	
33	100-80-160/3	10.5		3	

产品范围

4 极

序号	泵型号	Q [m <sup>3</sup> /h]	H [m]	配用电机 [kW]	n [r/min]
34	125-80-400/15	50	39	15	1480
35	125-80-400/18.5		45	18.5	
36	125-80-400/22		50	22	
37	125-80-400/30		60	30	
38	125-80-400/37		67	37	
39	125-100-200/4	100	9	4	1450
40	125-100-200/5.5		11.5	5.5	
41	125-100-200/7.5		14	7.5	
42	125-100-200/11		16.5	11	
43	125-100-250/15		25	15	
44	125-100-315/11		23	11	
45	125-100-315/18.5		32	18.5	
46	125-100-315/22		36	22	
47	125-100-315/30		40	30	
48	125-100-400/30		50	30	
49	125-100-400/37	58	37	1480	
50	125-100-400/45	65	45		
51	150-125-250/11	200	12.5		11
52	150-125-250/15		16		15
53	150-125-250/18.5		20		18.5
54	150-125-250/22		24		22
55	150-125-315/30		32		30
56	150-125-315/37		39		37
57	150-125-400/45		50		45
58	150-125-400/55		57		55
59	150-125-400/75		68		75
60	200-150-315/37		400		23
61	200-150-315/45	27			45
62	200-150-315/55	32			55
63	200-150-315/75	38			75
64	200-150-400/75	43			75
65	200-150-400/90	50			90
66	200-150-400/110	62			110
67	250-200-315/37	500	20		37
68	250-200-315/45		23		45
69	250-200-315/55	630	24		55
70	250-200-315/75		32		75
71	250-200-400/90		37		90
72	250-200-400/110		44		110
73	250-200-400/132		53		132
74	250-200-400/160		60	160	

产品范围

4 极

序号	泵型号	Q [m <sup>3</sup> /h]	H [m]	配用电机 [kW]	n [r/min]
75*	300-250-315(Q)/75	800	26	75	1480
76*	300-250-315(Q)/90		32	90	
77*	300-250-315(Q)/110		35	110	
78*	300-250-400(Q)/110		38	110	
79*	300-250-400(Q)/132		45	132	
80*	300-250-400(Q)/160		54	160	
81*	300-250-400(Q)/200		62	200	
82*	300-250-315/75		1000	23	
83*	300-250-315/90	27		90	
84*	300-250-315/110	32		110	
85*	300-250-400/132	37		132	
86*	300-250-400/160	45		160	
87*	300-250-400/200	50		200	

\*表示该产品目前只有NIS结构.

50-32-160/50-32-200

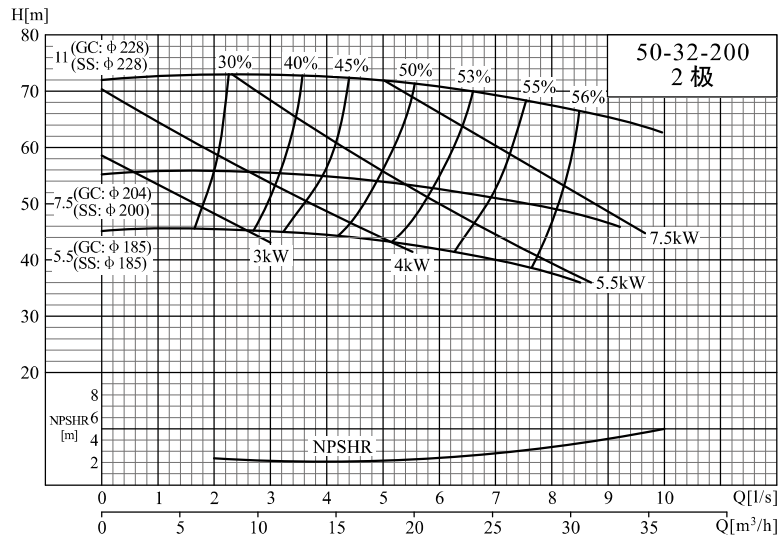
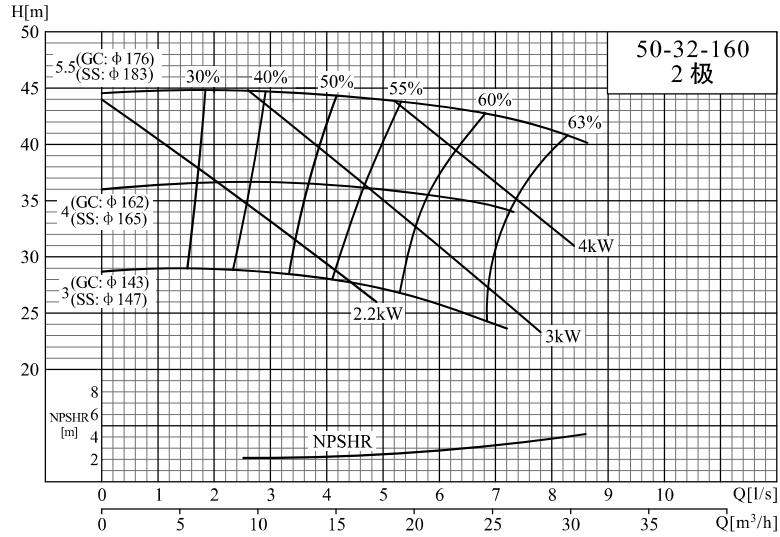

65-40-200/65-40-250

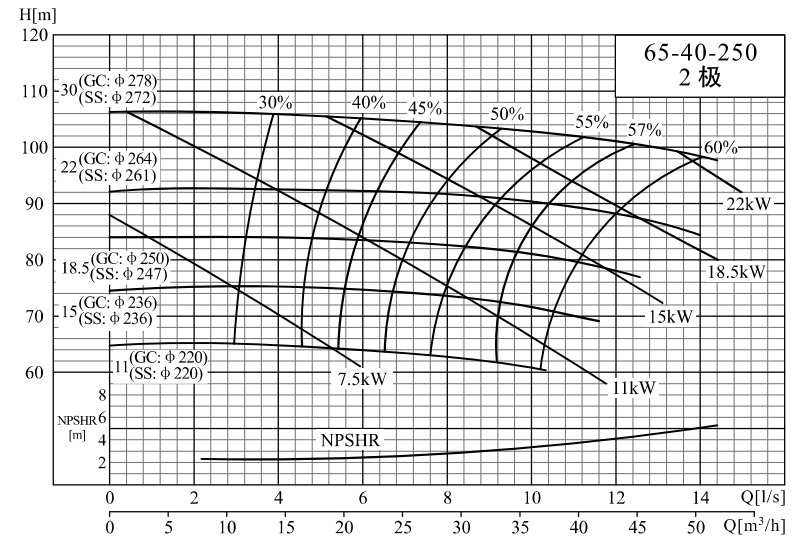
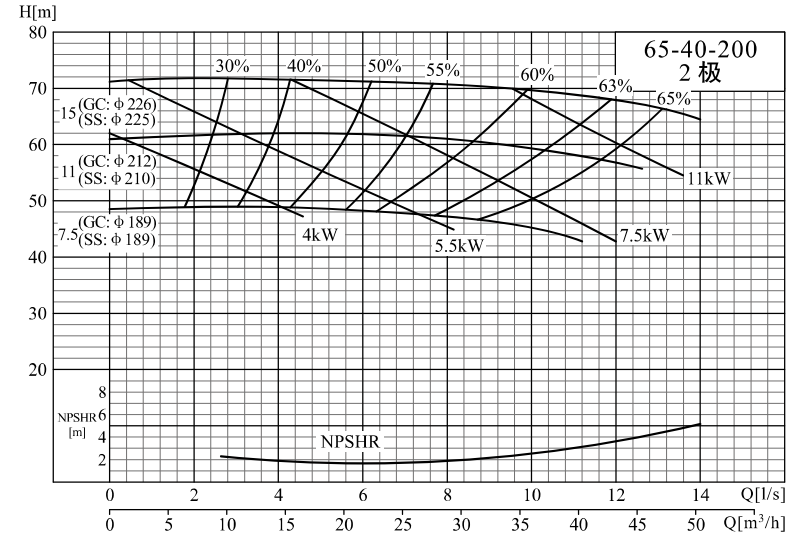

65-40-315/65-50-160

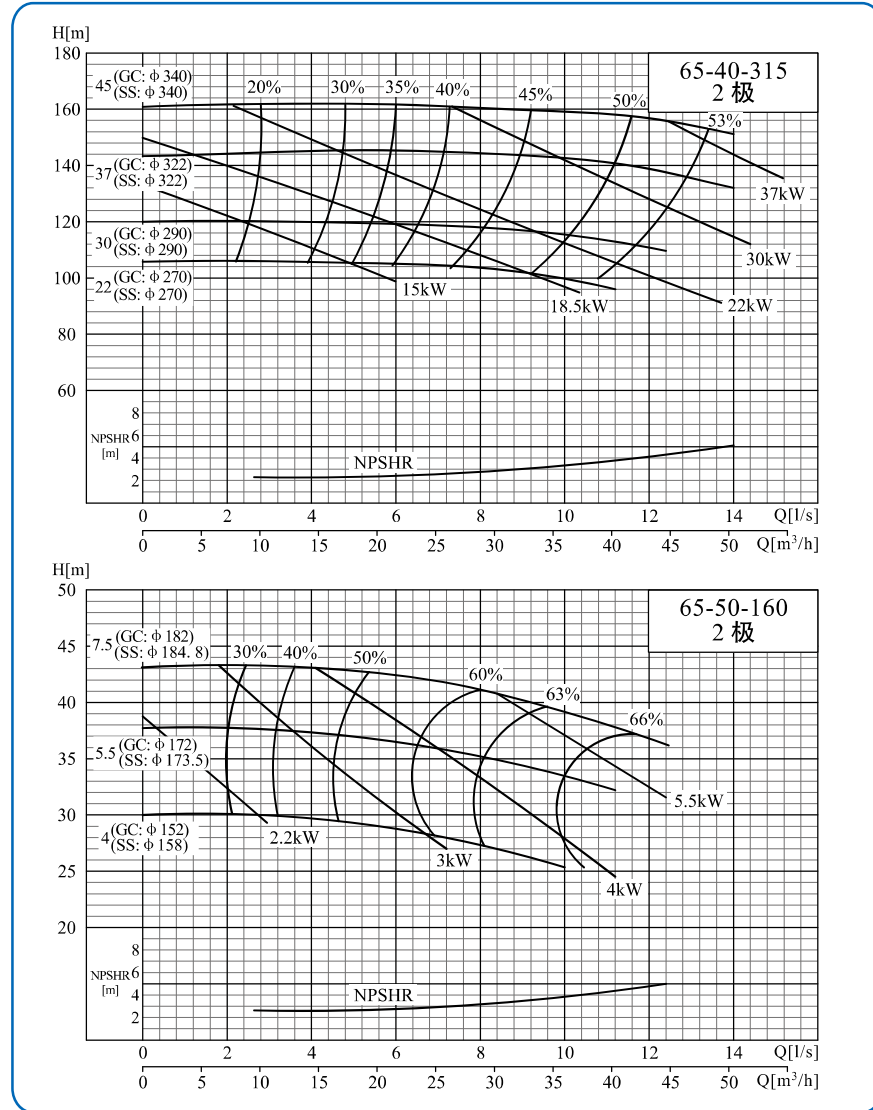

80-50-200/80-50-250

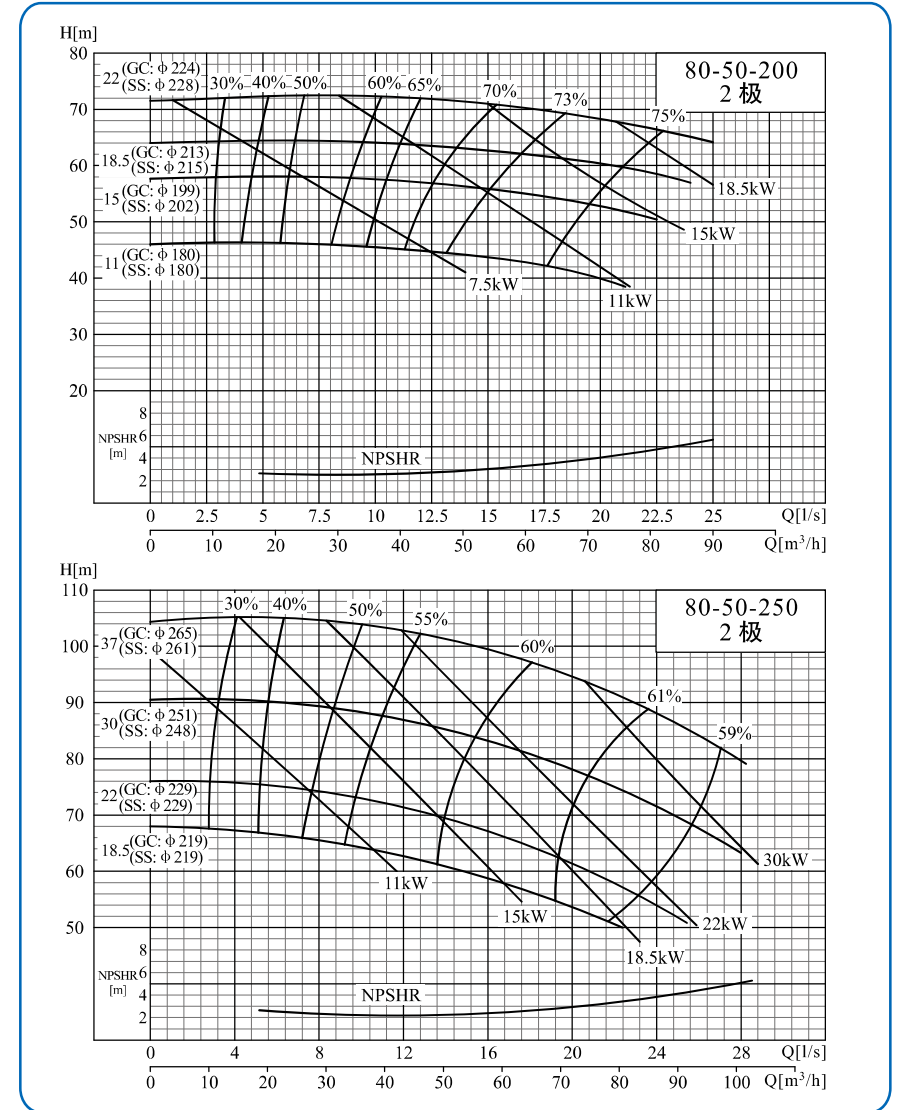

80-50-315/80-65-160

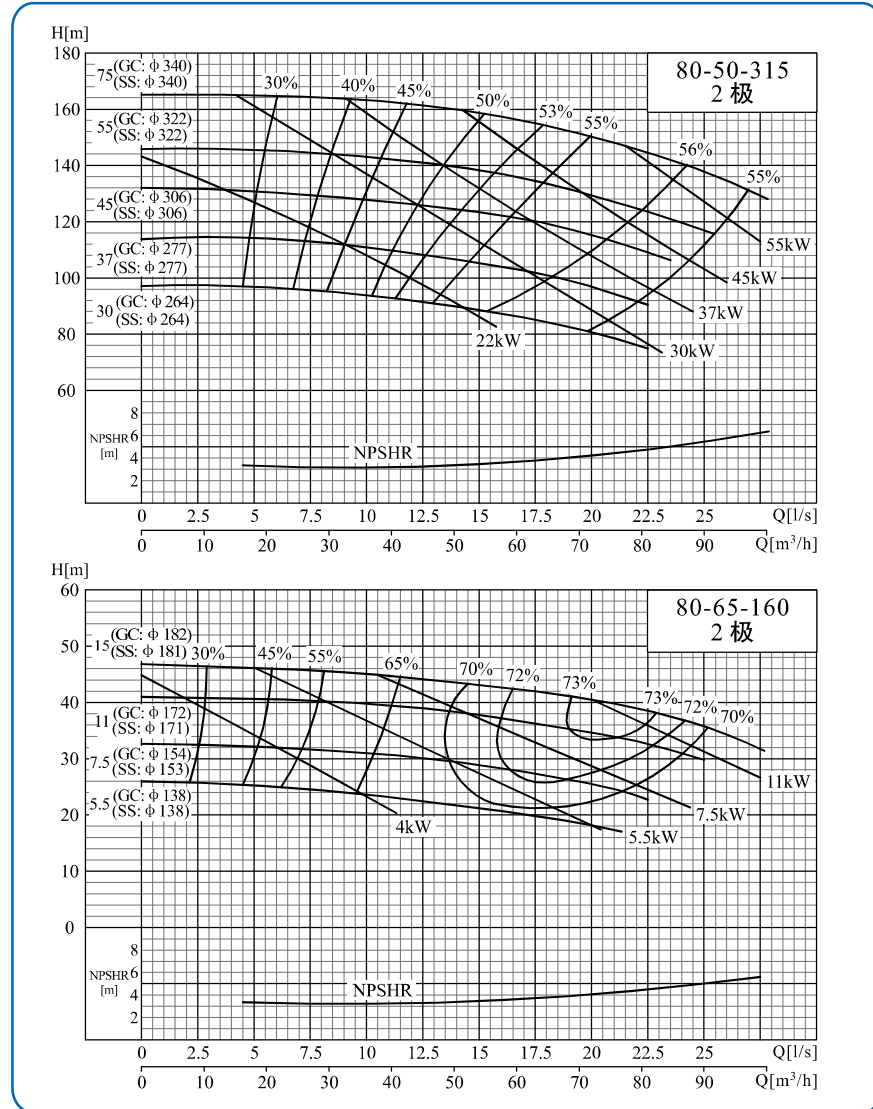

100-65-200/100-65-250

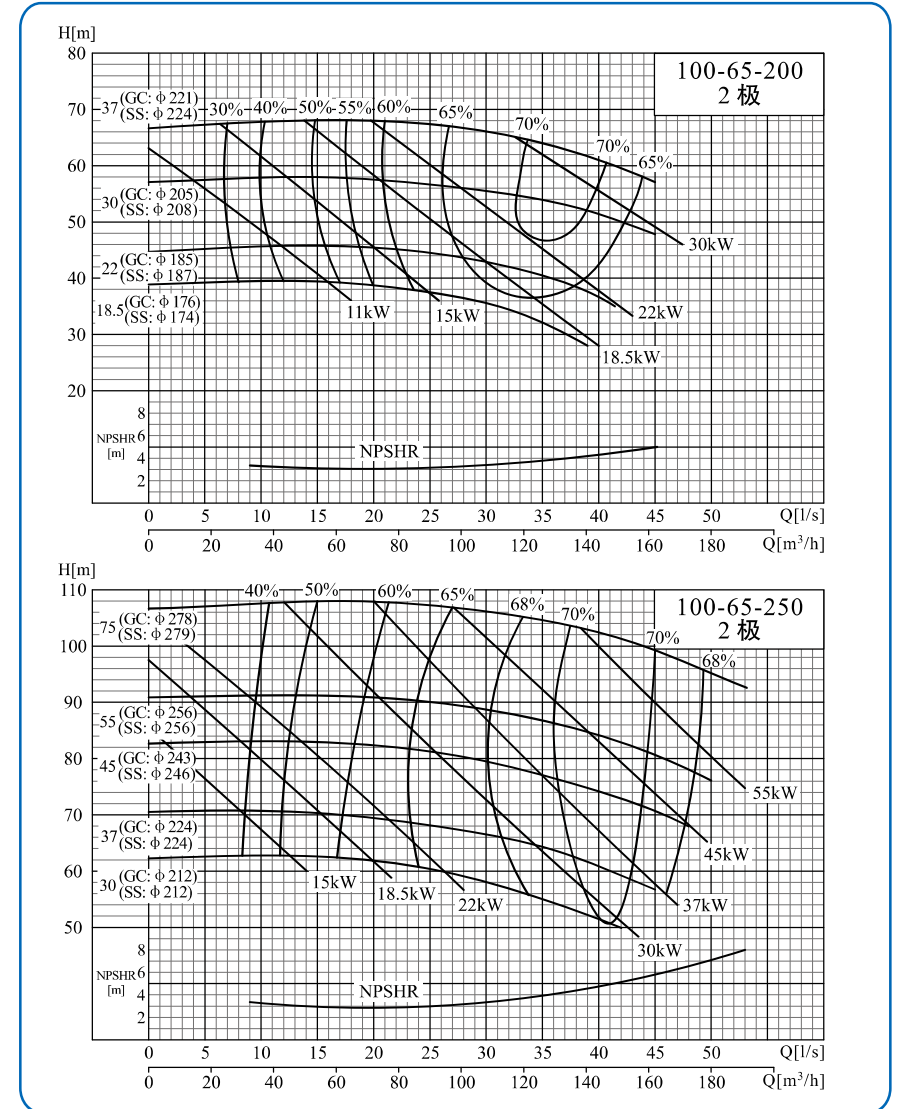



100-65-315/100-80-160

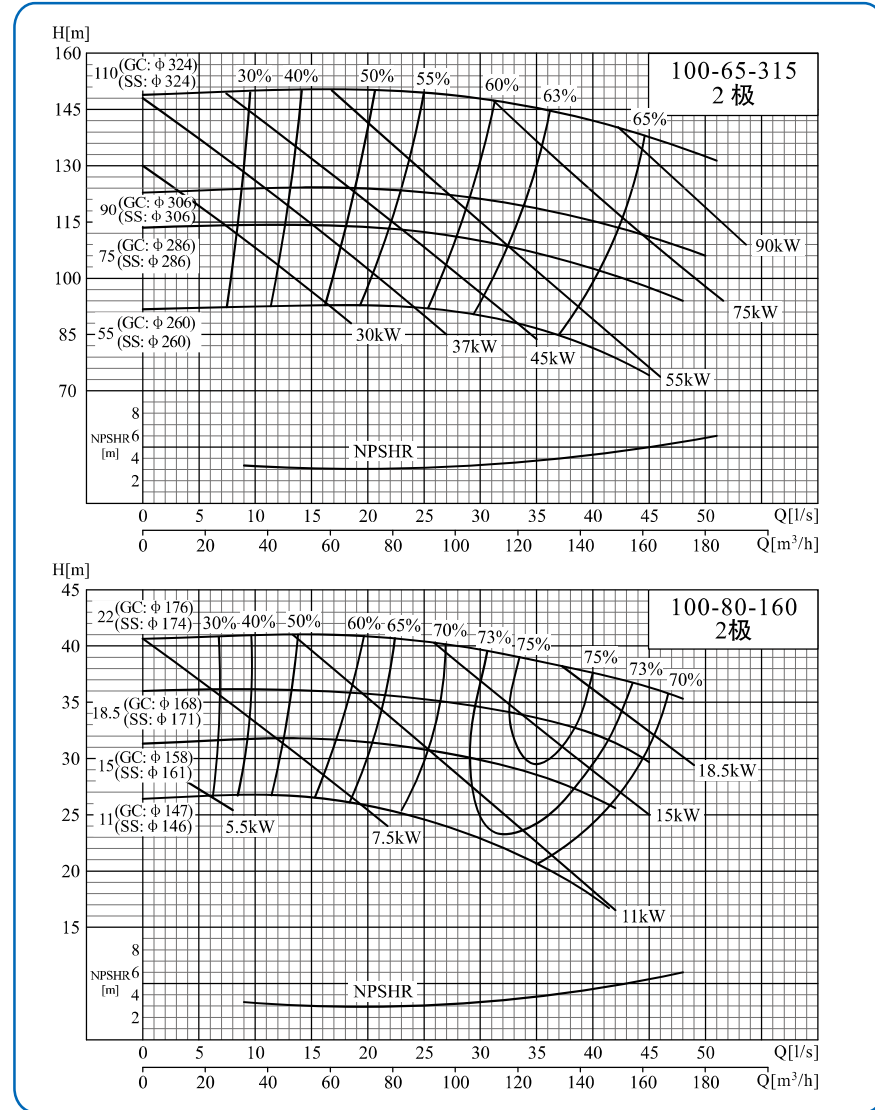

125-100-200/125-100-250

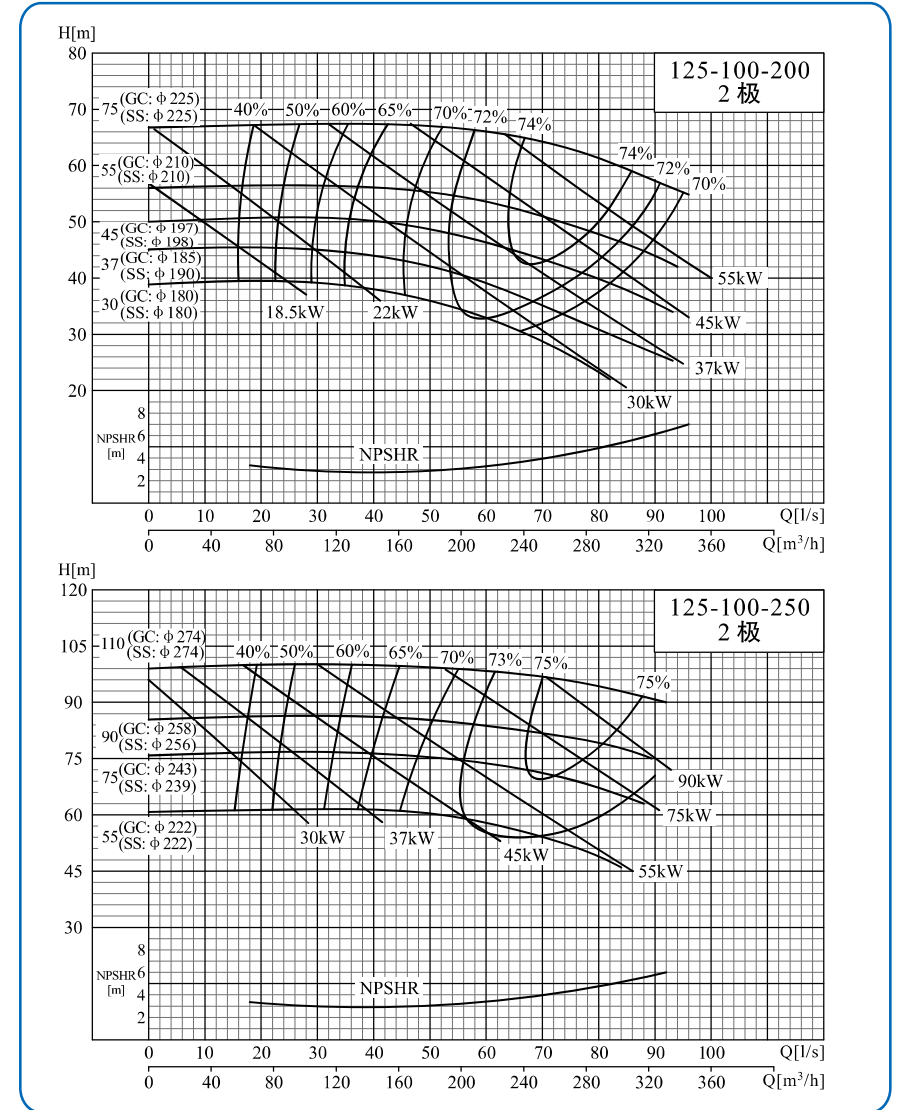

125-100-315/50-32-160

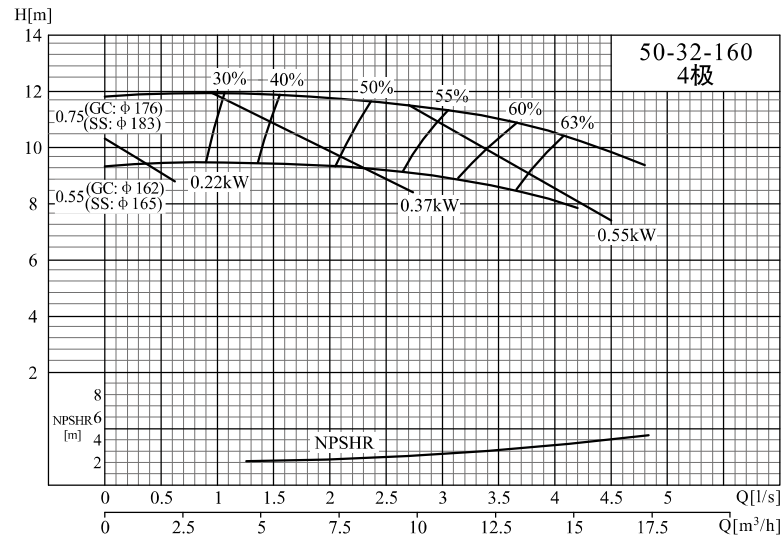
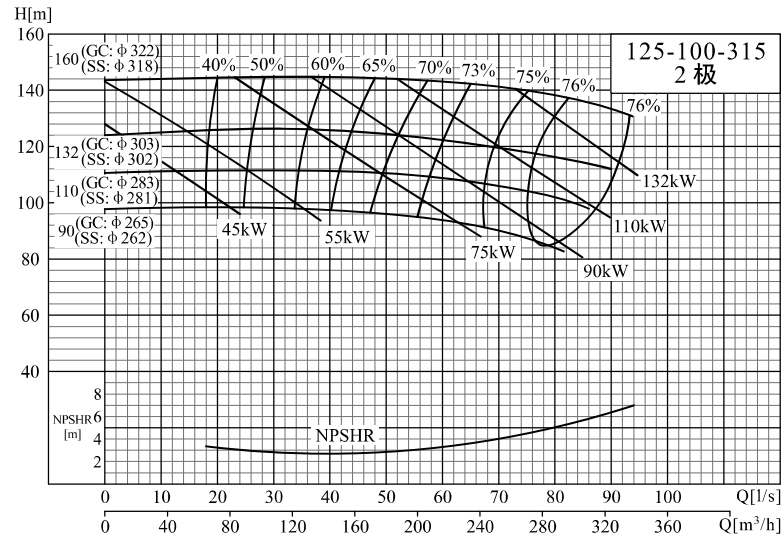

50-32-200/65-40-200

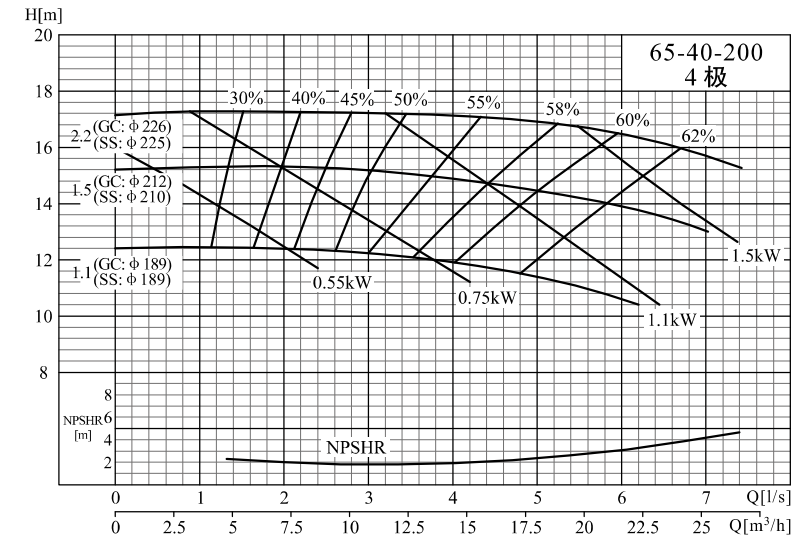
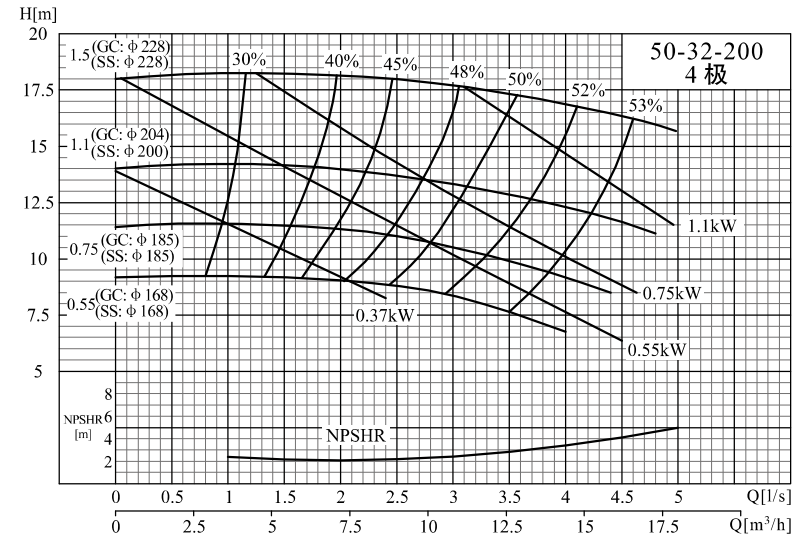

65-40-250/65-40-315

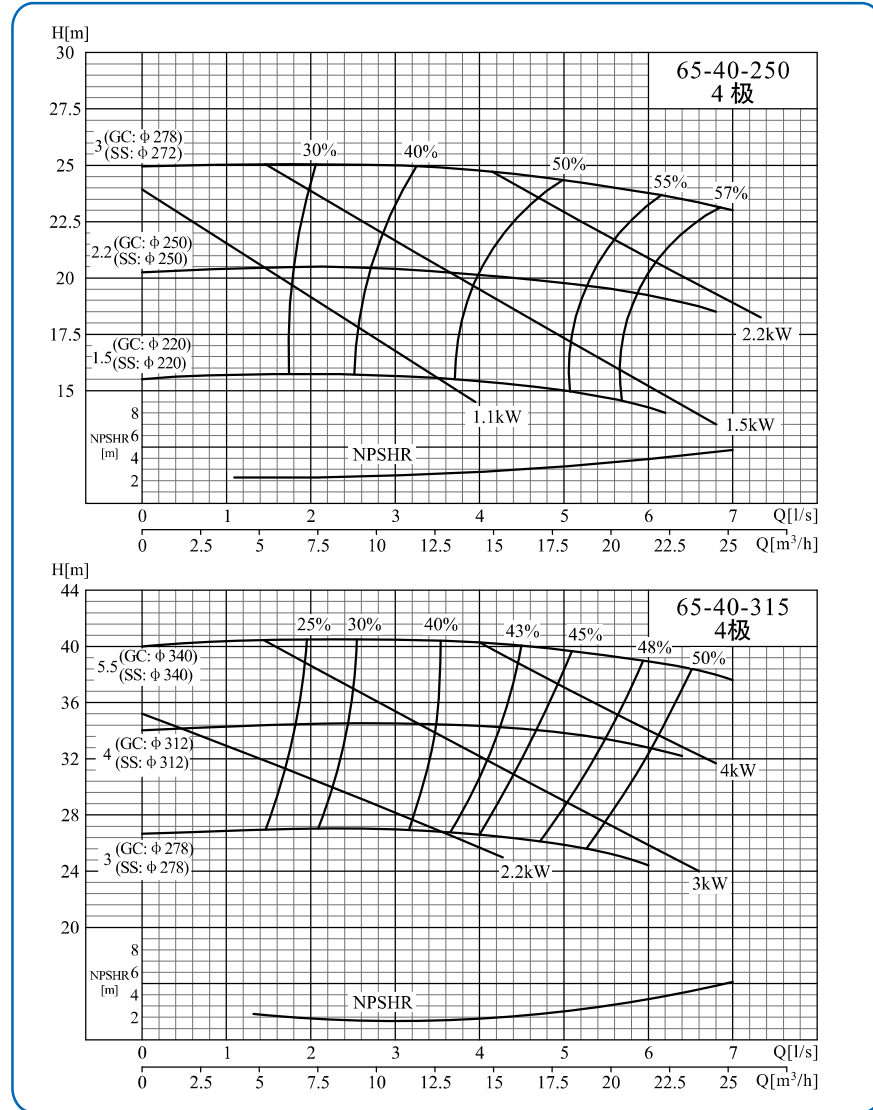

65-50-160/80-50-200

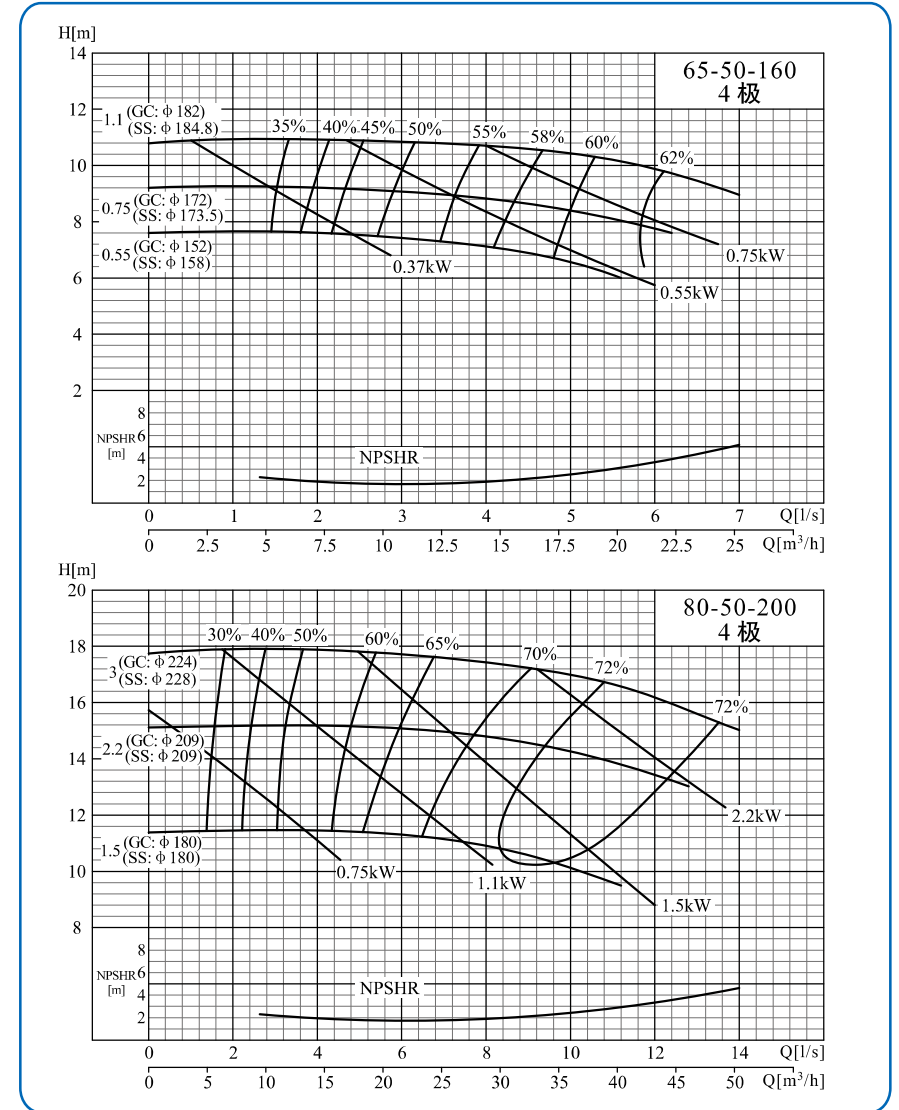

80-50-250/80-50-315

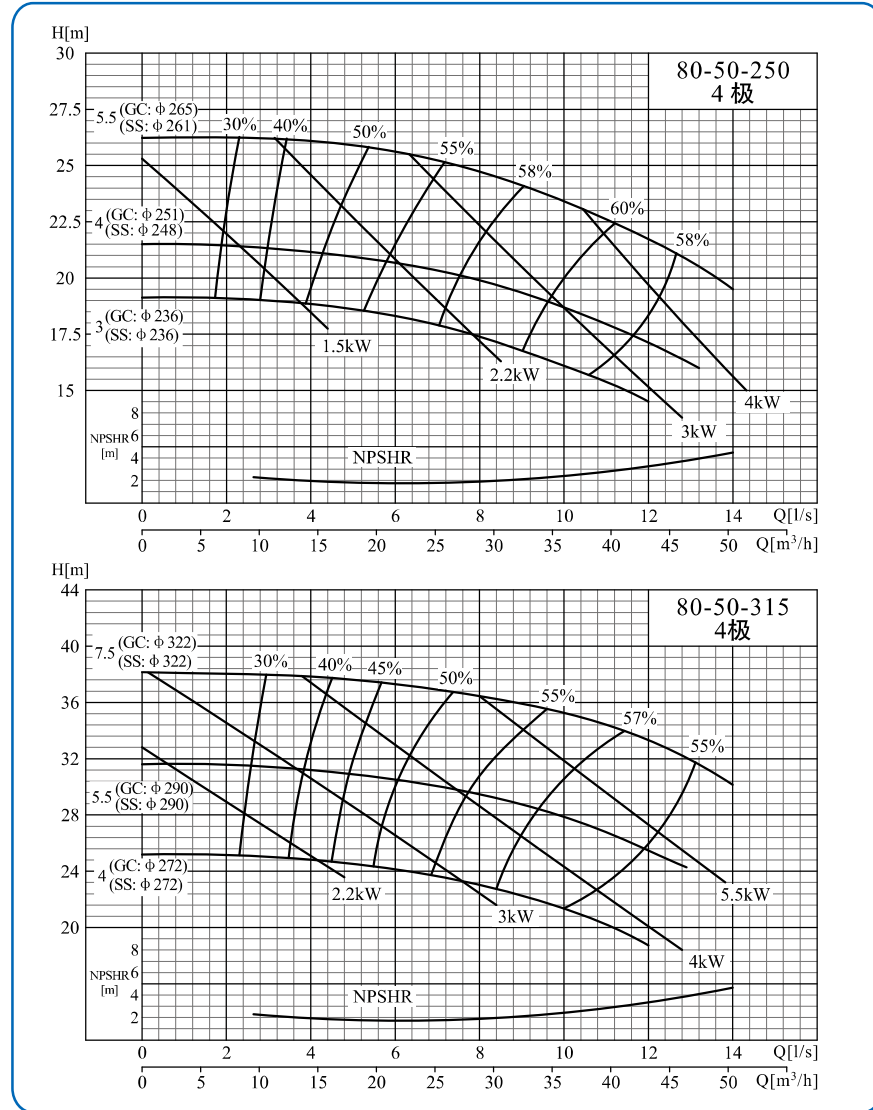

80-65-160/100-65-200

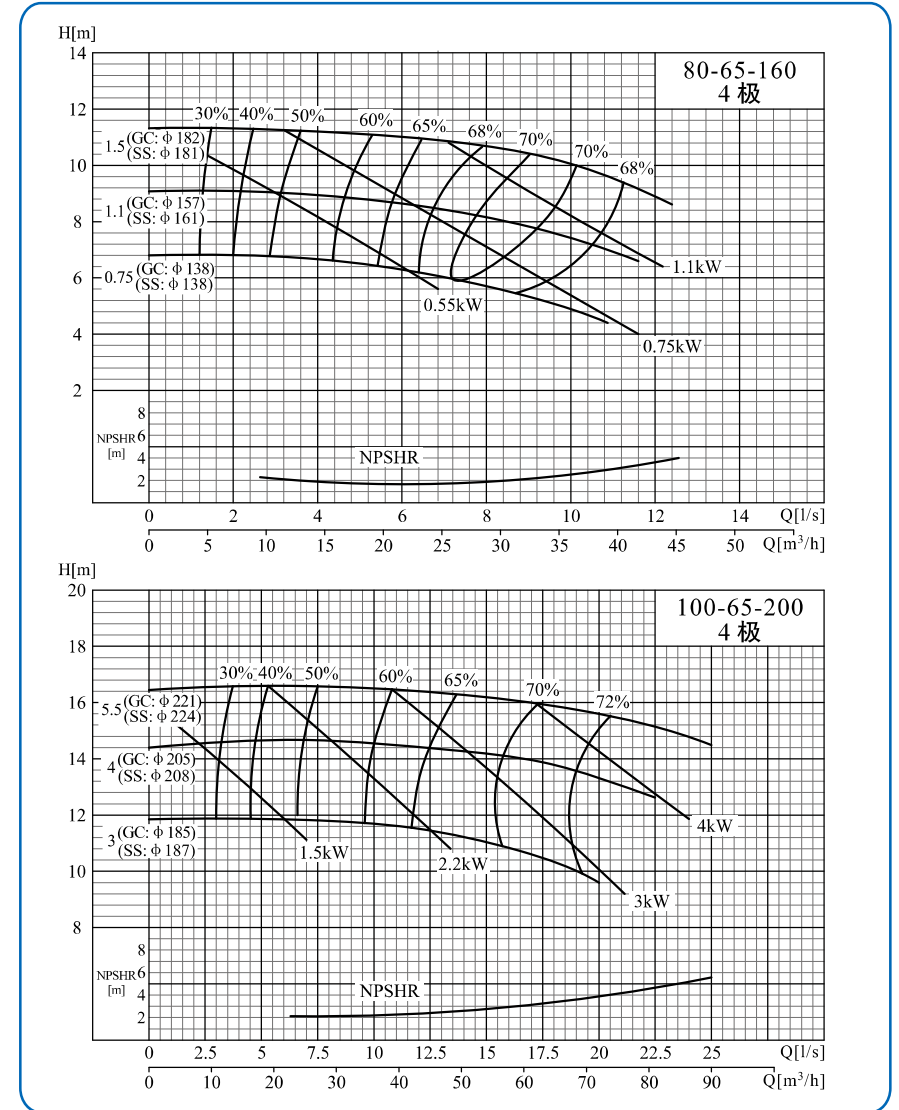

100-65-250/100-65-315

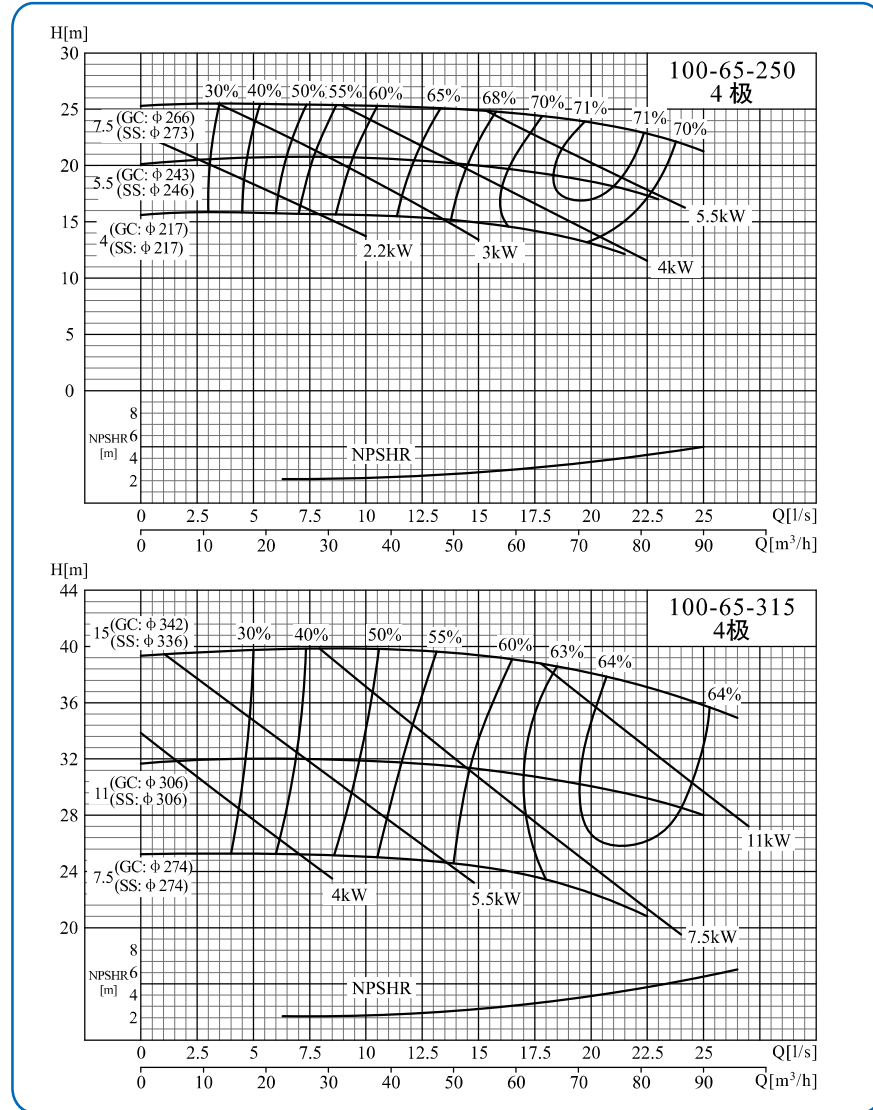

100-80-160/125-100-200

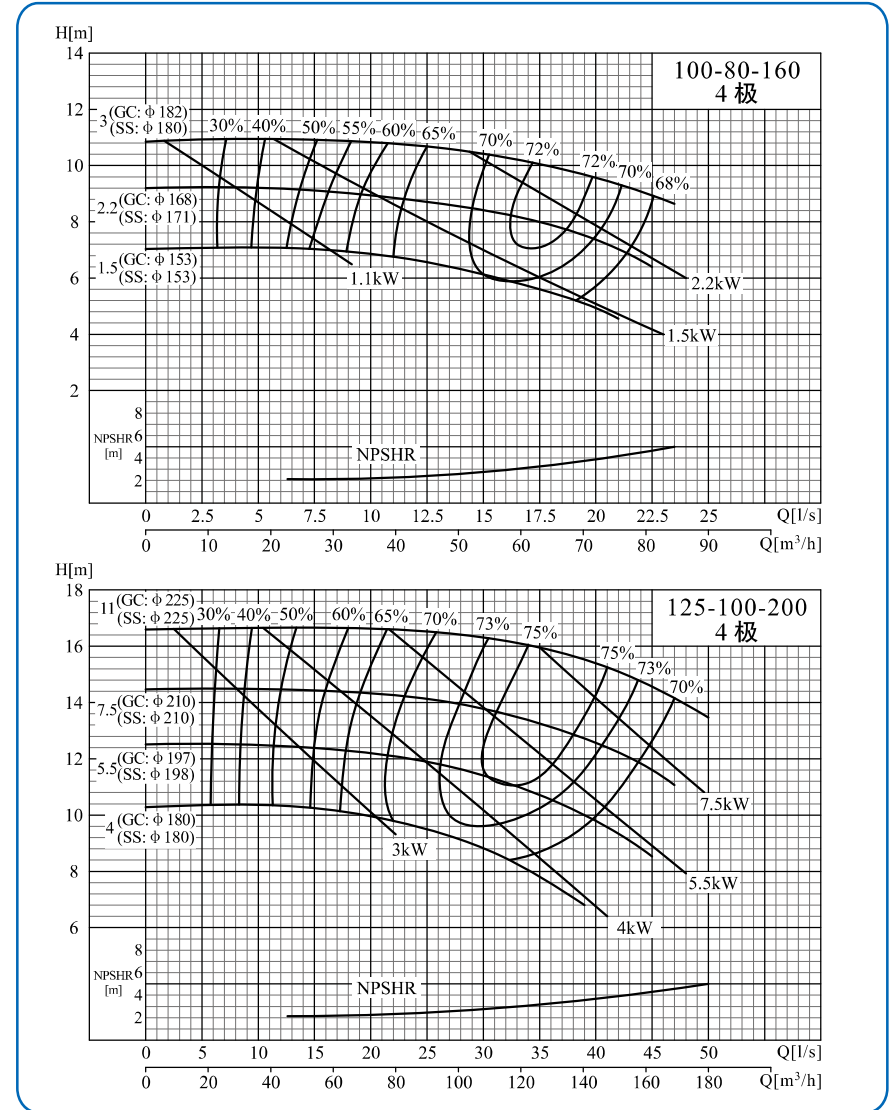

125-100-250/125-100-315

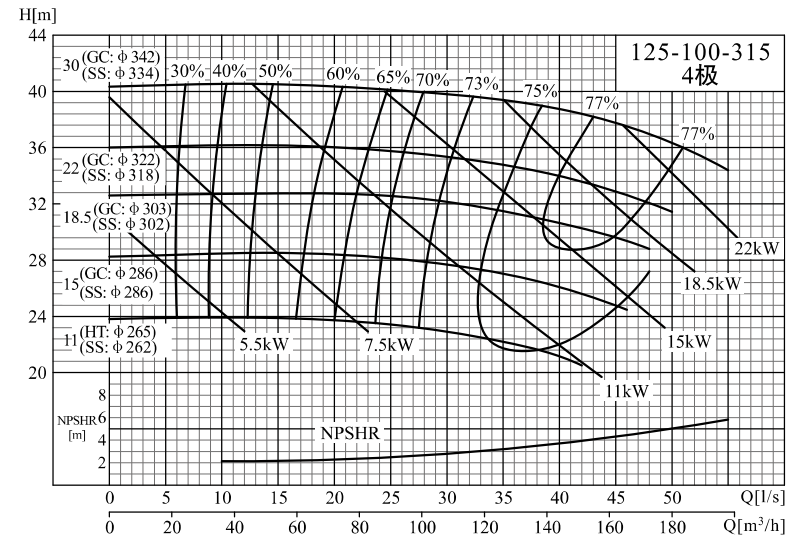
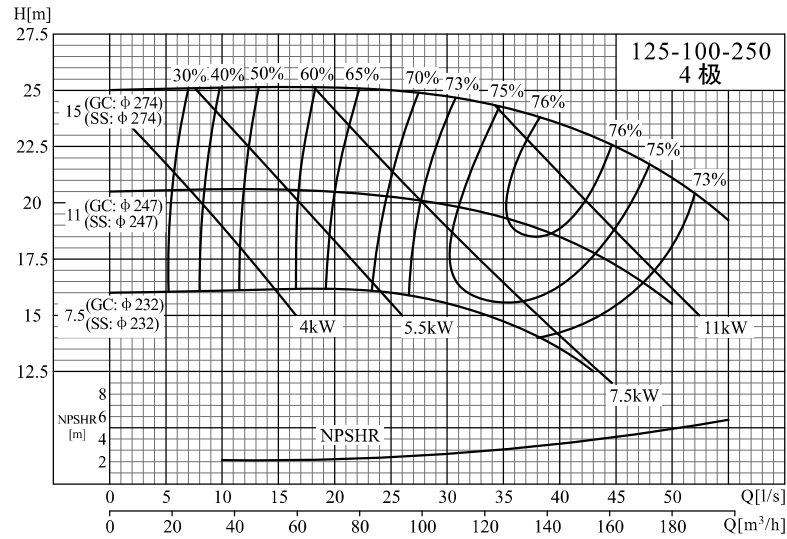

125-80-400/125-100-400

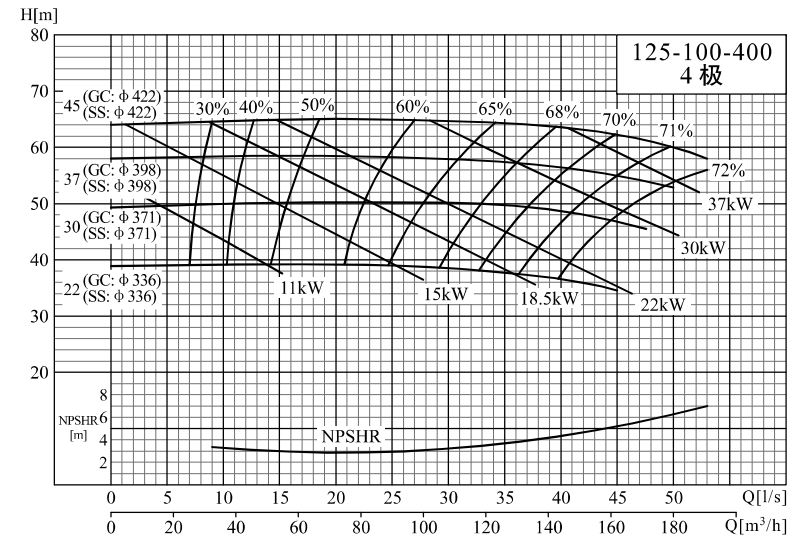
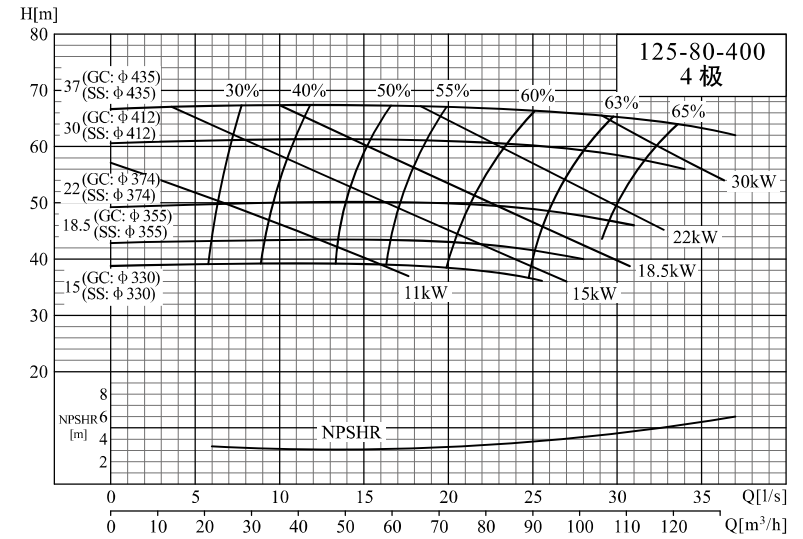



150-125-250/150-125-315

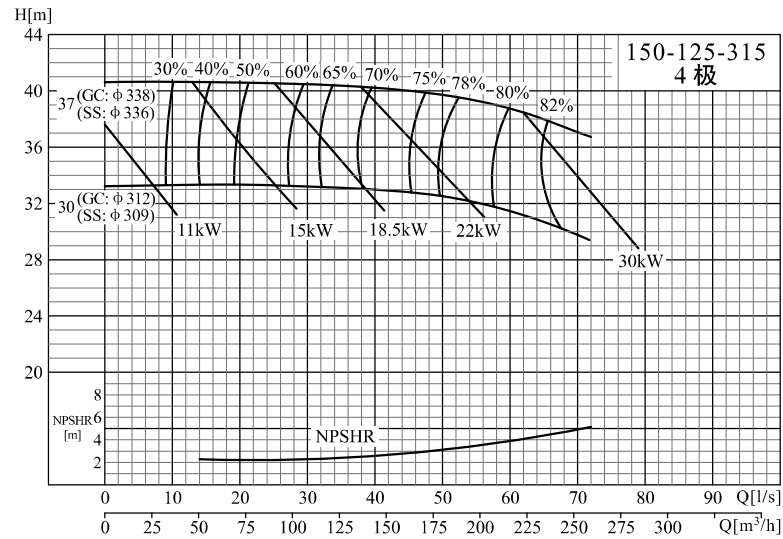
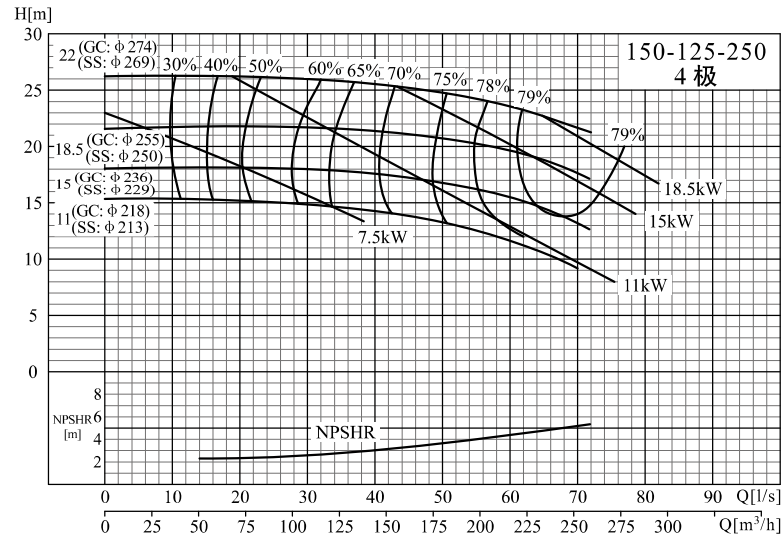

150-125-400/200-150-315

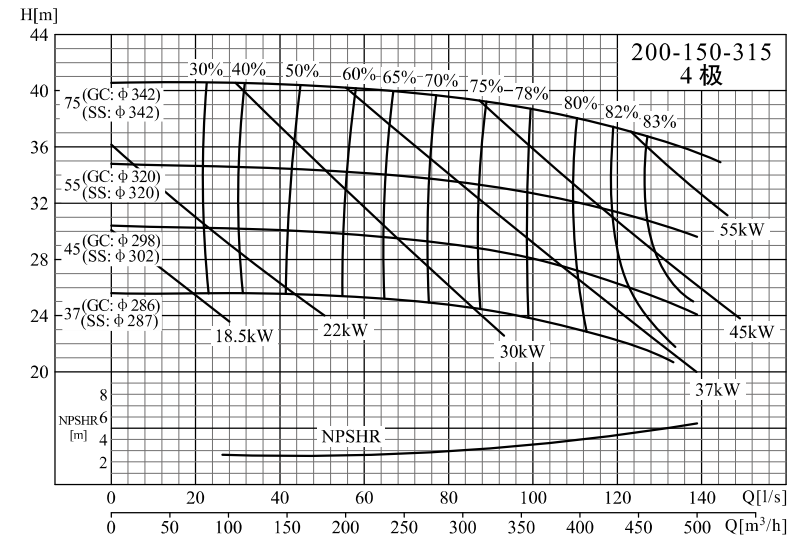
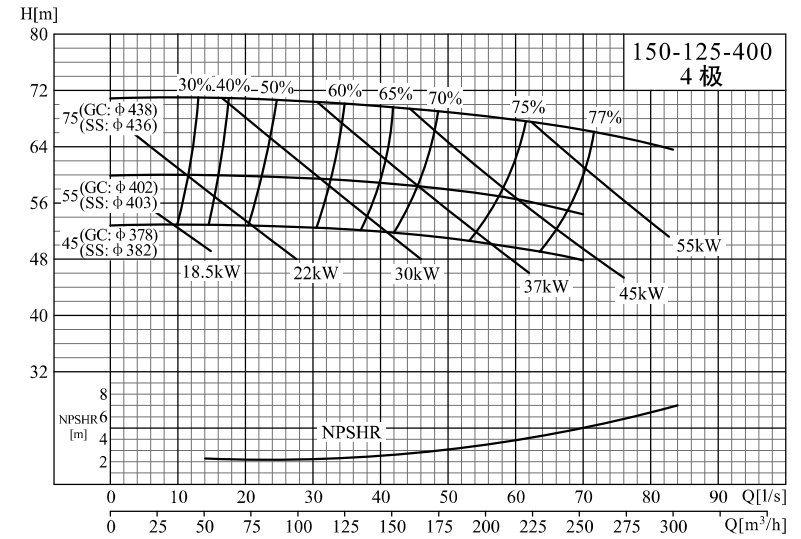

200-150-400/250-200-315

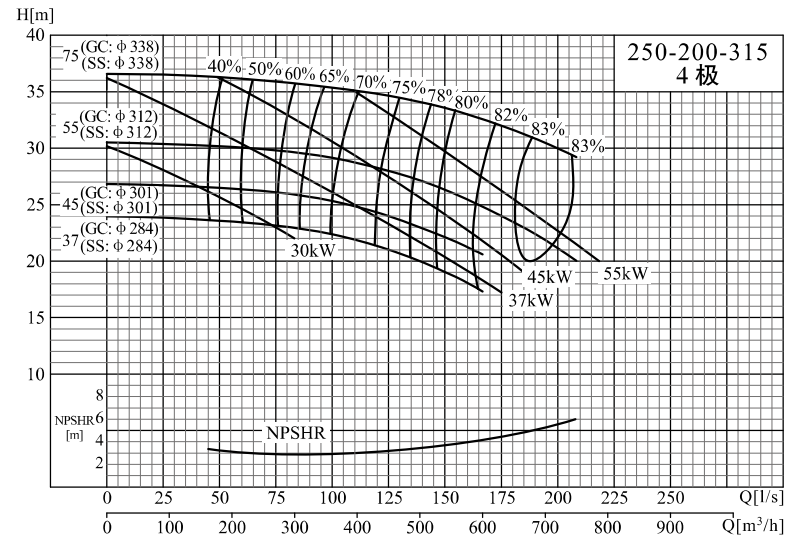
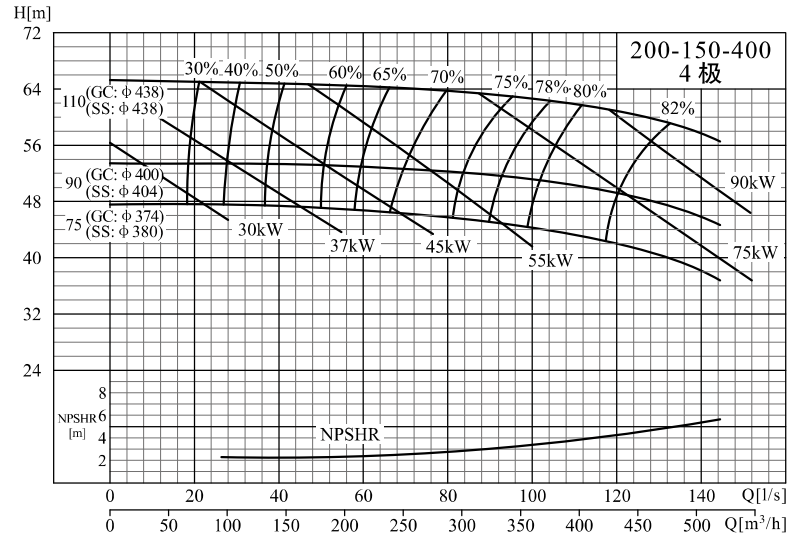

250-200-400/300-250-315(Q)

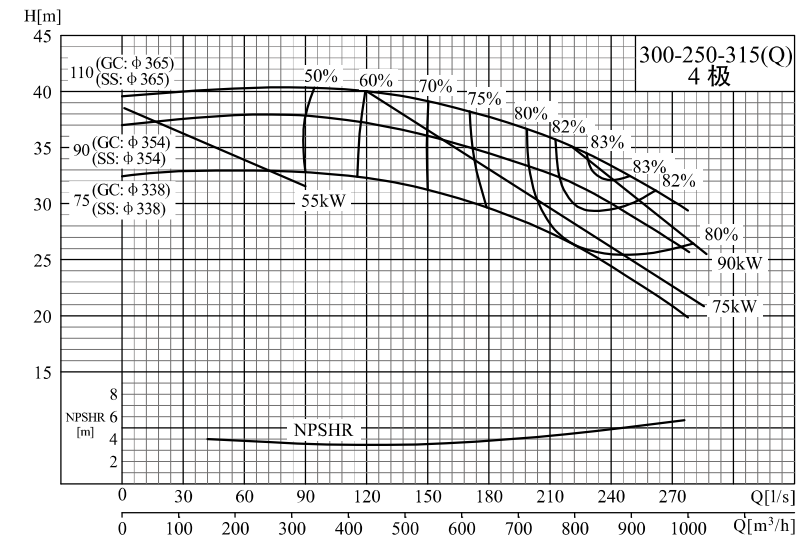
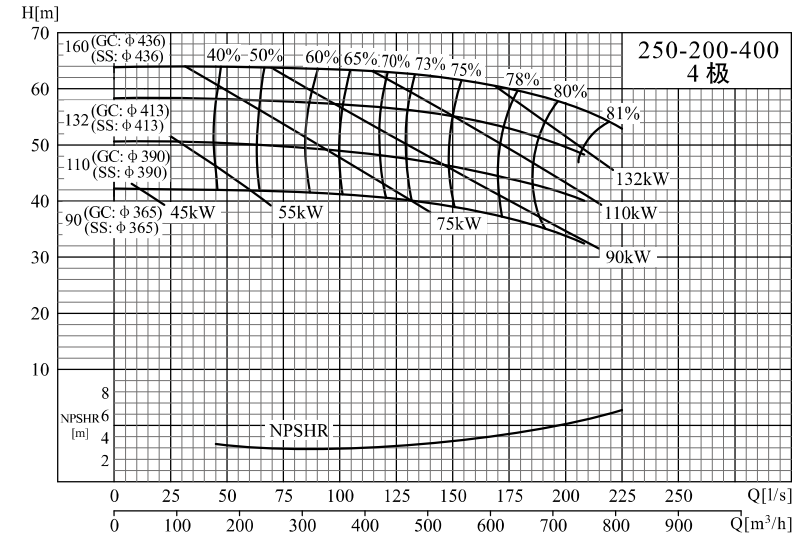

300-250-400(Q)/300-250-315

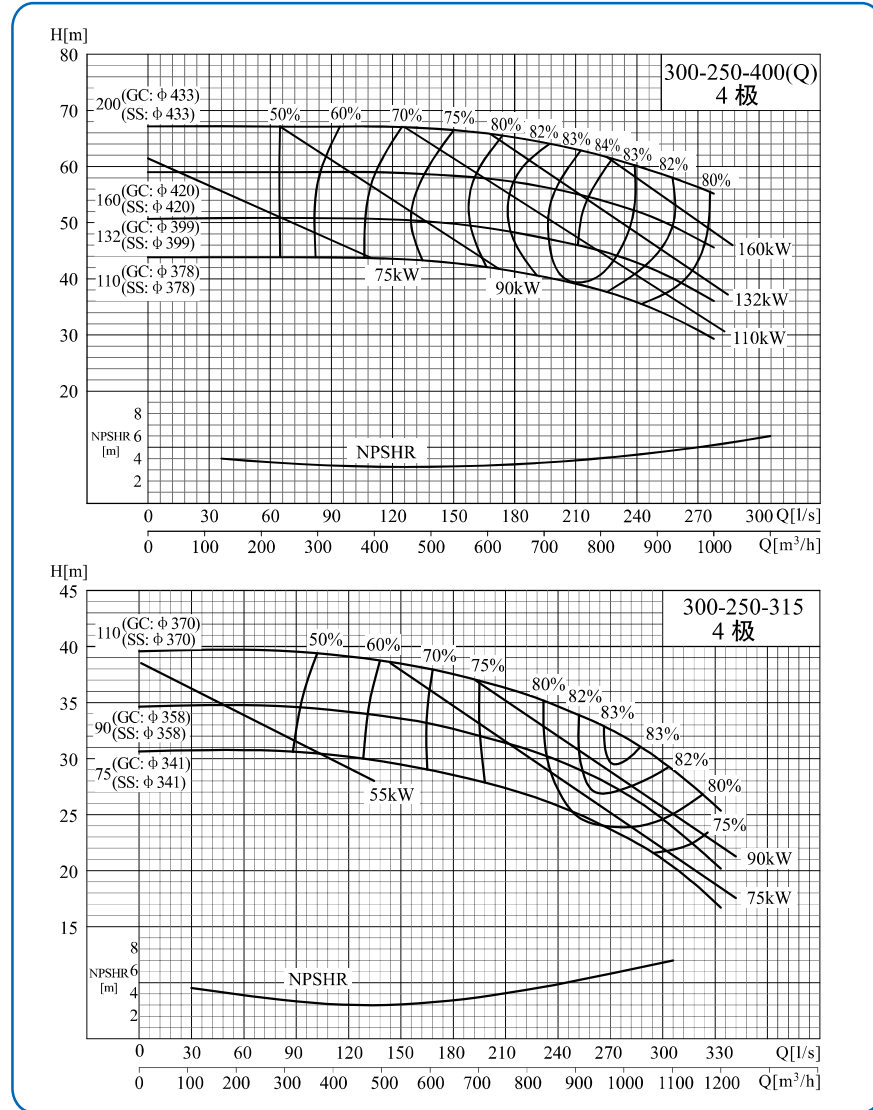

300-250-400

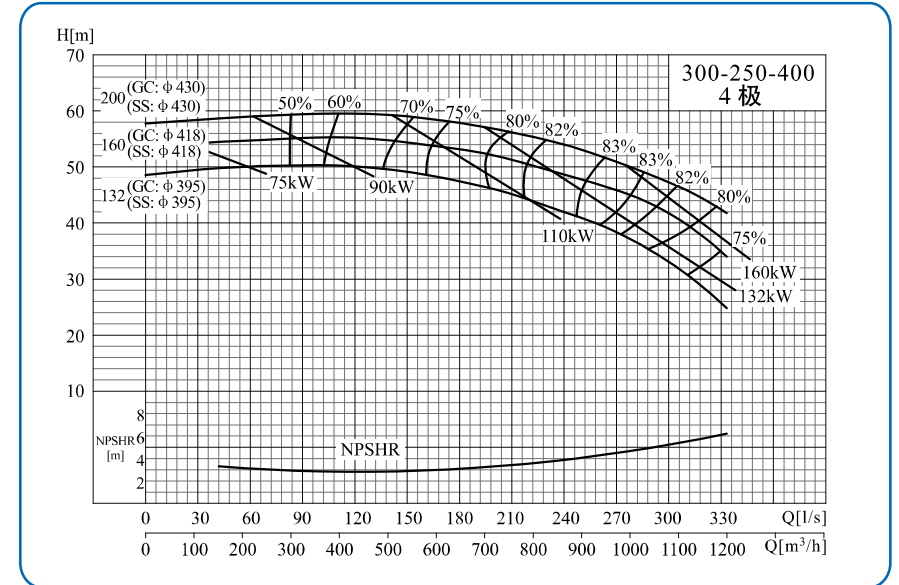

NISO泵外形尺寸图

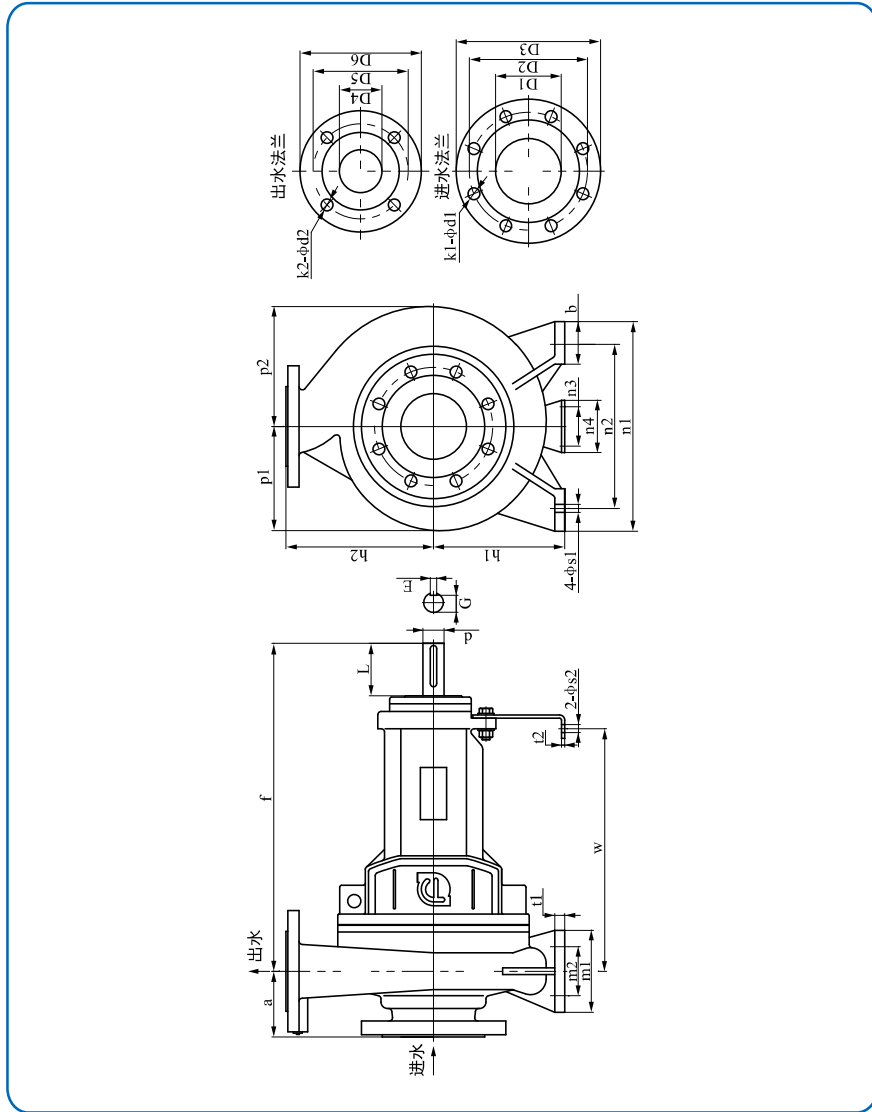

NISO泵外形尺寸表

序号	泵型号	泵外形尺寸						泵底板及安装尺寸											
		a	f	h1	h2	b	p1	p2	m1	m2	n1	n2	n3	n4	t1	t2	w	s1	s2
1	50-32-160	80	385	132	160	50	118	128	100	70	240	190	110	160	12	6	285	14	14
2	50-32-200	80	385	160	180	50	139	147	100	70	240	190	110	160	12	6	285	14	14
3	65-50-160	80	385	132	160	50	121	136	100	70	240	190	110	160	12	6	285	14	14
4	65-40-200	100	385	160	180	50	140	151	100	70	265	212	110	160	13	6	285	14	14
5	65-40-250	100	500	180	225	65	166	176	125	95	320	250	110	160	14	6	370	14	14
6	65-40-315	125	500	200	250	65	194	200	125	95	345	280	110	160	16	6	370	14	14
7	80-65-160	100	385	160	180	50	124	143	100	70	265	212	110	160	13	6	285	14	14
8	80-50-200	100	385	160	200	52	147	161	100	70	265	212	110	160	13	6	285	14	14
9	80-50-250	125	500	180	225	65	167	179	125	95	320	250	110	160	15	6	370	14	14
10	80-50-315	125	500	225	280	65	204	215	125	95	345	280	110	160	18	6	370	14	14
11	100-65-200	100	500	180	225	65	159	183	125	95	320	250	110	160	14	6	370	14	14
12	100-65-250	125	500	200	250	80	180	201	160	120	360	280	110	160	16	6	370	18	14
13	100-65-315	125	530	225	280	80	210	228	160	120	400	315	110	160	18	6	370	18	14
14	100-80-160	100	500	160	200	65	132	160	125	95	280	212	110	160	14	6	370	14	14
15	125-80-400	125	530	280	355	80	261	279	160	120	435	355	110	160	20	6	370	18	14
16	125-100-200	125	500	200	280	80	175	210	160	120	360	280	110	160	17	6	370	18	14
17	125-100-250	140	530	225	280	80	193	225	160	120	400	315	110	160	18	6	370	18	14
18	125-100-315	140	530	250	315	80	224	250	160	120	400	315	110	160	19	6	370	18	14
19	125-100-400	140	530	280	355	100	265	287	200	150	500	400	110	160	20	6	370	18	14
20	150-125-250	140	530	250	355	80	204	244	160	120	400	315	110	160	19	6	370	18	14
21	150-125-315	140	530	280	355	100	236	271	200	150	500	400	110	160	20	6	370	22	14
22	150-125-400	140	530	315	400	100	273	301	200	150	500	400	110	160	21	6	370	22	14
23	200-150-315	160	670	315	400	82	255	304	200	150	515	450	140	180	25	10	500	22	18
24	200-150-400	160	670	315	450	82	291	330	200	150	515	450	140	180	25	10	500	22	18
25	250-200-315	180	670	315	450	82	278	344	200	150	515	450	140	180	25	10	500	22	18
26	250-200-400	180	670	380	450	82	314	367	200	150	515	450	140	180	25	10	500	22	18

续表

序号	泵型号	进水法兰尺寸					出水法兰尺寸					轴伸端尺寸				重量 (kg)
		D1	D2	D3	k1	d1	D4	D5	D6	k2	d2	D	L	E	G	
1	50-32-160	50	125	165	4	18	32	100	140	4	18	24	50	8	20	38
2	50-32-200	50	125	165	4	18	32	100	140	4	18	24	50	8	20	43
3	65-50-160	65	145	185	4	18	50	125	165	4	18	24	50	8	20	41
4	65-40-200	65	145	185	4	18	40	110	150	4	18	24	50	8	20	45
5	65-40-250	65	145	185	4	18	40	110	150	4	18	32	80	10	27	68
6	65-40-315	65	145	185	4	18	40	110	150	4	18	32	80	10	27	84
7	80-65-160	80	160	200	8	18	65	145	185	4	18	24	50	8	20	44
8	80-50-200	80	160	200	8	18	50	125	165	4	18	24	50	8	20	48
9	80-50-250	80	160	200	8	18	50	125	165	4	18	32	80	10	27	71
10	80-50-315	80	160	200	8	18	50	125	165	4	18	32	80	10	27	90
11	100-65-200	100	180	220	8	18	65	145	185	4	18	32	80	10	27	67
12	100-65-250	100	180	220	8	18	65	145	185	4	18	32	80	10	27	82
13	100-65-315	100	180	220	8	18	65	145	185	4	18	42	110	12	37	120
14	100-80-160	100	180	220	8	18	80	160	200	8	18	32	80	10	27	70
15	125-80-400	125	210	250	8	18	80	160	200	8	18	42	110	12	37	158
16	125-100-200	125	210	250	8	18	100	180	220	8	18	32	80	10	27	88
17	125-100-250	125	210	250	8	18	100	180	220	8	18	42	110	12	37	122
18	125-100-315	125	210	250	8	18	100	180	220	8	18	42	110	12	37	137
19	125-100-400	125	210	250	8	18	100	180	220	8	18	42	110	12	37	163
20	150-125-250	150	240	285	8	22	125	210	250	8	18	42	106	12	37	129
21	150-125-315	150	240	285	8	22	125	210	250	8	18	42	106	12	37	157
22	150-125-400	150	240	285	8	22	125	210	250	8	18	42	106	12	37	181
23	200-150-315	200	295	340	12	22	150	240	285	8	22	60	110	18	53	222
24	200-150-400	200	295	340	12	22	150	240	285	8	22	60	110	18	53	293
25	250-200-315	250	355	405	12	26	200	295	340	12	22	60	110	18	53	258
26	250-200-400	250	355	405	12	26	200	295	340	12	22	60	110	18	53	328

NISO泵组外形尺寸图

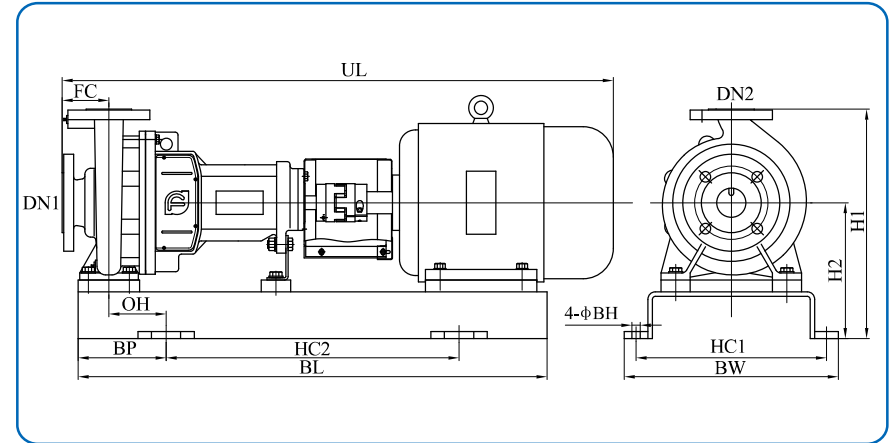

NISO泵组外形尺寸表

2 极

型号	功率 (kW)	H1	H2	HC1	HC2	BW	BL	BP	BH	OH	UL	FC	DN1	DN2	总重量 (kg)
50-32-160	3	392	232	296	500	336	750	125	14	72.5	857	80	50	32	95
	4	392	232	296	500	336	750	125	14	72.5	875	80	50	32	109
	5.5	392	232	325	500	365	800	150	14	97.5	941	80	50	32	133
50-32-200	7.5	440	243	340	600	380	860	130	14	77.5	941	80	50	32	146
	11	440	260	380	600	420	950	175	18	121	1077	80	50	32	190
65-40-200	7.5	440	260	325	500	365	800	150	14	97.5	961	100	65	40	145
	11	440	260	380	600	420	950	175	18	121	1097	100	65	40	192
	15	440	260	380	600	420	950	175	18	121	1097	100	65	40	208
65-40-250	18.5	505	280	380	800	420	1080	140	18	73.5	1282	100	65	40	255
	22	505	280	420	800	480	1100	150	18	81.5	1319	100	65	40	291
	30	525	300	460	800	500	1180	190	18	121.5	1379	100	65	40	363
65-40-315	22	550	300	420	800	460	1100	150	18	81.5	1344	125	65	40	307
	30	570	320	455	800	495	1200	200	18	131.5	1412	125	65	40	392
	37	570	320	455	800	495	1200	200	18	131.5	1412	125	65	40	403
65-40-315	45	590	340	510	800	560	1250	225	22	155	1466	125	65	40	453
	4	392	232	296	500	336	750	125	14	72.5	875	80	65	50	112
	5.5	392	232	325	500	365	800	150	14	97.5	941	80	65	50	135
65-50-160	7.5	392	232	325	500	365	800	150	14	97.5	941	80	65	50	141

续表

2 极

型号	功率 (kW)	H1	H2	HC1	HC2	BW	BL	BP	BH	OH	UL	FC	DN1	DN2	总重量 (kg)
80-50-200	11	460	260	380	600	420	950	175	18	121	1097	100	80	50	194
	15	460	260	380	600	420	950	175	18	121	1097	100	80	50	210
	18.5	460	260	380	600	420	950	175	18	121	1137	100	80	50	222
	22	480	280	420	700	460	1000	150	18	96	1194	100	80	50	268
80-50-250	30	525	300	460	800	500	1180	190	18	121.5	1404	125	80	50	367
	37	525	300	460	800	495	1180	190	18	121.5	1404	125	80	50	377
80-50-315	37	625	345	455	800	495	1200	200	18	131.5	1402	125	80	50	410
	45	625	345	510	800	560	1250	225	22	155	1466	125	80	50	451
	55	650	370	575	900	625	1300	200	22	130	1547	125	80	50	573
	75	680	400	620	800	670	1400	300	22	230	1620	125	80	50	703
80-65-160	5.5	440	260	325	500	365	800	150	14	97.5	961	100	80	65	139
	7.5	440	260	325	500	365	800	150	14	97.5	961	100	80	65	144
	11	440	260	380	600	420	950	175	18	121	1097	100	80	65	191
	15	440	260	380	600	420	950	175	18	121	1097	100	80	65	206
100-65-200	18.5	505	280	380	800	420	1080	140	18	73.5	1282	100	100	65	254
	22	505	280	420	800	460	1100	150	18	81.5	1319	100	100	65	290
	30	525	300	460	800	500	1180	190	18	121.5	1379	100	100	65	362
	37	525	300	460	800	500	1180	190	18	121.5	1379	100	100	65	372
100-65-250	45	590	340	510	800	550	1250	225	22	141.5	1466	125	100	65	444
	55	620	370	575	900	625	1350	225	22	141.5	1547	125	100	65	576
	75	650	400	620	800	670	1400	300	22	214	1620	125	100	65	695
100-65-315	90	680	400	620	900	670	1450	275	22	189	1700	125	100	65	771
	110	720	440	710	1000	760	1500	250	22	164	1909	125	100	65	1278
100-80-160	11	460	260	380	800	420	1080	140	18	73.5	1212	100	100	80	221
	15	460	260	380	800	420	1080	140	18	73.5	1212	100	100	80	237
	18.5	460	260	380	800	420	1080	140	18	73.5	1282	100	100	80	253
	22	480	280	420	800	460	1100	150	18	83.5	1319	100	100	80	293
125-100-200	30	600	320	455	800	495	1200	200	18	119	1412	125	125	100	390
	37	600	320	455	800	495	1200	200	18	119	1412	125	125	100	400
	45	620	340	510	800	560	1250	225	22	141.5	1466	125	125	100	449
	55	650	370	575	900	625	1350	225	22	141.5	1547	125	125	100	580
	75	680	400	620	800	670	1400	300	22	214	1620	125	125	100	699

续表

2 极

型号	功率 (kW)	H1	H2	HC1	HC2	BW	BL	BP	BH	OH	UL	FC	DN1	DN2	总重量 (kg)
125-100-250	75	680	400	620	800	670	1400	300	22	214	1665	140	125	100	734
	90	680	400	620	900	670	1450	275	22	189	1715	140	125	100	774
	110	720	440	710	1000	760	1500	250	22	164	1924	140	125	100	1278
	125-100-315	90	715	400	620	900	670	1450	275	22	189	1715	140	125	100
125-100-315	110	755	440	710	1000	760	1500	250	22	164	1909	140	125	100	1238
	132	755	440	710	1000	760	1560	280	22	194	2034	140	125	100	1344
	160	755	440	710	1000	760	1560	280	22	194	2034	140	125	100	1441

NISO泵组外形尺寸表

4 极

型号	功率 (kW)	H1	H2	HC1	HC2	BW	BL	BP	BH	OH	UL	FC	DN1	DN2	总重量 (kg)
50-32-160	0.55	392	232	296	500	336	700	100	14	47.5	755	80	50	32	78
	0.75	392	232	296	500	336	700	100	14	47.5	755	80	50	32	79
50-32-200	1.1	440	260	296	500	336	750	125	14	72.5	794	80	50	32	89
	1.5	440	260	296	500	336	750	125	14	72.5	819	80	50	32	91
65-40-200	1.1	440	260	325	500	365	750	125	14	72.5	824	100	65	40	92
	1.5	440	260	325	500	365	750	125	14	72.5	849	100	65	40	94
	2.2	440	260	325	500	365	750	125	14	72.5	887	100	65	40	107
65-40-250	3	505	280	376	600	416	920	160	14	95	992	100	65	40	141
65-40-315	4	550	300	405	600	445	900	150	14	85	1045	125	65	40	171
	5.5	550	300	405	600	445	950	175	14	110	1101	125	65	40	192
65-50-160	0.55	392	232	296	500	336	700	100	14	47.5	755	80	65	50	81
	0.75	392	232	296	500	336	700	100	14	47.5	755	80	65	50	81
	1.1	392	232	296	500	336	700	100	14	47.5	794	80	65	50	85
80-50-200	1.5	460	260	325	500	365	750	125	14	72.5	849	100	80	50	96
	2.2	460	260	325	500	365	750	125	14	72.5	877	100	80	50	109
	3	460	260	325	500	365	750	125	14	72.5	877	100	80	50	113
80-50-250	4	505	280	376	600	416	920	160	14	95	1042	125	80	50	155
	5.5	505	280	376	600	416	920	160	14	95	1107	125	80	50	173
80-50-315	5.5	605	325	405	600	445	950	175	18	108.5	1101	125	80	50	199
	7.5	605	325	405	600	445	950	175	18	108.5	1141	125	80	50	211
80-65-160	0.75	440	260	325	500	365	700	100	14	47.5	775	100	80	65	84
	1.1	440	260	325	500	365	750	125	14	72.5	824	100	80	65	91
	1.5	440	260	325	500	365	750	125	14	72.5	849	100	80	65	93



续表

4极

型号	功率(kW)	H1	H2	HC1	HC2	BW	BL	BP	BH	OH	UL	FC	DN1	DN2	总重量(kg)
100-65-200	3	505	280	376	600	416	920	160	14	95	992	100	100	65	140
	4	505	280	376	600	416	920	160	14	95	1017	100	100	65	150
	5.5	505	280	376	600	416	920	160	14	95	1082	100	100	65	169
100-65-250	5.5	550	300	420	600	460	980	190	14	110	1111	125	100	65	190
	7.5	550	300	420	600	460	980	190	18	110	1151	125	100	65	203
100-65-315	11	605	325	460	800	500	1120	160	18	80	1267	125	100	65	298
	15	605	325	460	800	500	1120	160	18	80	1307	125	100	65	312
100-80-160	1.5	460	260	340	600	380	860	130	14	65	954	100	100	80	124
	2.2	460	260	340	600	380	860	130	14	65	982	100	100	80	135
	3	460	260	340	600	380	860	130	14	65	982	100	100	80	139
125-80-400	15	735	380	500	800	540	1150	175	18	94	1317	125	125	80	362
	18.5	735	380	500	800	540	1150	175	18	94	1374	125	125	80	381
	22	735	380	510	800	560	1220	210	22	126.5	1404	125	125	80	418
	30	735	380	510	800	560	1220	210	22	126.5	1442	125	125	80	474
125-100-200	4	580	300	420	600	460	900	150	14	70	1045	125	125	100	171
	5.5	580	300	420	600	460	980	190	18	110	1111	125	125	100	195
	7.5	580	300	420	600	460	980	190	18	110	1151	125	125	100	207
	11	580	300	420	800	460	1100	150	18	70	1237	125	125	100	263
125-100-250	15	605	325	460	800	500	1120	160	18	80	1322	140	125	100	312
125-100-315	11	665	350	460	800	500	1120	160	18	79	1282	140	125	100	314
	18.5	665	350	460	800	500	1180	190	18	109	1379	140	125	100	354
	22	665	350	460	800	500	1180	190	18	109	1409	140	125	100	380
	30	665	350	510	800	560	1220	210	22	126.5	1457	140	125	100	452
125-100-400	30	735	380	570	800	620	1220	210	22	110	1447	140	125	100	478
	37	755	400	575	900	625	1300	200	22	100	1496	140	125	100	552
	45	755	400	575	900	625	1300	200	22	100	1531	140	125	100	581
150-125-250	11	705	350	460	800	500	1120	160	18	79	1282	140	150	125	309
	15	705	350	460	800	500	1120	160	18	79	1322	140	150	125	324
	18.5	705	350	460	800	500	1180	190	18	109	1379	140	150	125	349
	22	705	350	460	800	500	1180	190	18	109	1409	140	150	125	375

续表

4极

型号	功率(kW)	H1	H2	HC1	HC2	BW	BL	BP	BH	OH	UL	FC	DN1	DN2	总重量(kg)
150-125-315	30	735	380	570	800	620	1220	210	22	110	1447	140	150	125	483
	37	755	400	575	900	625	1300	200	22	100	1496	140	150	125	559
150-125-400	45	835	435	575	900	625	1300	200	22	100	1531	140	150	125	607
	55	835	435	575	900	625	1350	225	22	125	1592	140	150	125	709
	75	835	435	620	800	670	1400	300	22	200	1665	140	150	125	844
200-150-315	37	835	435	620	800	670	1400	300	22	200	1656	160	200	150	628
	45	835	435	595	900	645	1500	300	22	200	1691	160	200	150	659
	55	835	435	595	900	645	1500	300	22	200	1752	160	200	150	762
200-150-400	75	835	435	625	1000	675	1600	300	22	200	1835	160	200	150	903
	75	885	435	625	1000	675	1600	300	22	200	1835	160	200	150	973
	90	885	435	625	1000	675	1600	300	22	200	1885	160	200	150	1024
250-200-315	110	885	435	710	1200	760	1700	250	22	150	2124	160	200	150	1467
	37	885	435	620	800	670	1400	300	22	200	1676	180	250	200	663
	45	885	435	595	900	645	1500	300	22	200	1711	180	250	200	694
250-200-400	55	885	435	595	900	645	1500	300	22	200	1772	180	250	200	798
	75	885	435	625	1000	675	1600	300	22	200	1855	180	250	200	943
	90	950	500	625	1000	675	1600	300	22	200	1905	180	250	200	1075
250-200-400	110	950	500	710	1200	760	1700	250	22	150	2144	180	250	200	1524
	132	950	500	710	1200	760	1750	275	22	175	2244	180	250	200	1606
	160	950	500	710	1200	760	1750	275	22	175	2244	180	250	200	1710

NIS, NISF泵外形尺寸图

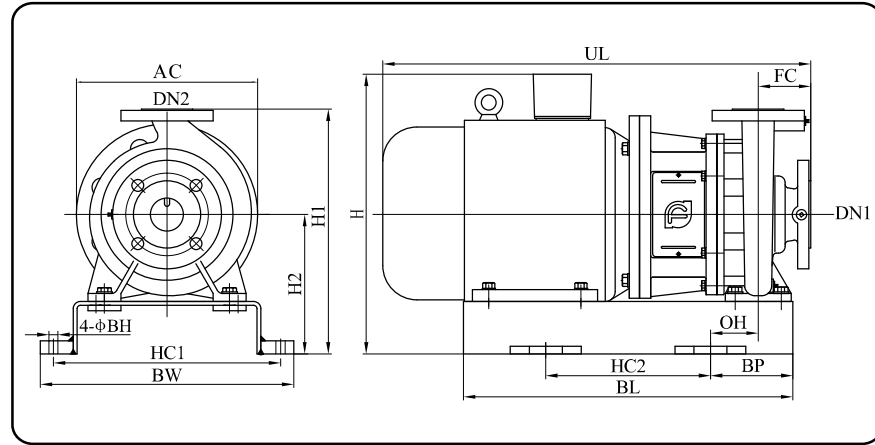

NIS, NISF泵外形尺寸表

2极

型号	功率 (kW)	H	H1	H2	HC1	HC2	BW	BL	BP	BH	OH	UL	FC	DN1	DN2	总重量 (kg)
50-32-160	3	382	372	212	306	250	336	450	100	14	47.5	563	80	50	32	75
	4	400	372	212	306	250	336	450	100	14	47.5	578	80	50	32	81
	5.5	425	372	212	335	300	365	500	100	14	47.5	650	80	50	32	105
50-32-200	7.5	453	420	240	350	300	380	500	100	14	46	650	80	50	32	120
	11	500	420	240	390	350	420	600	125	18	71	787	80	50	32	175
65-40-200	7.5	453	420	240	335	300	365	500	100	14	47.5	670	100	65	40	120
	11	500	420	240	390	350	420	600	125	18	71	807	100	65	40	177
	15	500	420	240	390	350	420	600	125	18	71	807	100	65	40	187
65-40-250	18.5	520	485	260	390	400	420	660	130	18	63.5	865	100	65	40	222
	22	535	485	260	430	400	460	700	150	18	81.5	895	100	65	40	257
	30	585	505	280	470	450	500	750	150	18	81.5	967	100	65	40	318
65-40-315	22	555	530	280	430	400	460	700	150	18	81.5	920	125	65	40	270
	30	585	530	280	465	500	495	800	150	18	81.5	992	125	65	40	340
	37	585	530	280	465	500	495	800	150	18	81.5	992	125	65	40	359
	45	640	555	305	520	500	560	820	160	22	90	1042	125	65	40	428
65-50-160	4	400	372	212	306	250	336	450	100	14	47.5	578	80	65	50	83
	5.5	425	372	212	335	300	365	500	100	14	47.5	650	80	65	50	107
	7.5	425	372	212	335	300	365	500	100	14	47.5	650	80	65	50	110

续表

2极

型号	功率 (kW)	H	H1	H2	HC1	HC2	BW	BL	BP	BH	OH	UL	FC	DN1	DN2	总重量 (kg)
80-50-200	11	500	440	240	390	350	420	600	125	18	71	807	100	80	50	181
	15	500	440	240	390	350	420	600	125	18	71	807	100	80	50	191
	18.5	500	440	240	390	400	420	660	130	18	76	862	100	80	50	211
	22	535	460	260	430	400	460	700	150	18	96	892	100	80	50	254
80-50-250	30	585	505	280	470	450	500	750	150	18	81.5	992	125	80	50	320
	37	585	505	280	470	450	500	750	150	18	81.5	992	125	80	50	339
80-50-315	37	610	585	305	465	500	495	800	150	18	81.5	992	125	80	50	370
	45	640	585	305	520	500	560	820	160	22	90	1042	125	80	50	434
	55	715	630	350	585	550	625	950	200	22	130	1156	125	80	50	534
	75	780	660	380	630	600	670	1000	200	22	130	1231	125	80	50	675
80-65-160	5.5	453	420	240	335	300	365	500	100	14	47.5	670	100	80	65	115
	7.5	453	420	240	335	300	365	500	100	14	47.5	670	100	80	65	118
	11	500	420	240	390	350	420	600	125	18	71	807	100	80	65	175
	15	500	420	240	390	350	420	600	125	18	71	807	100	80	65	185
100-65-200	18.5	520	485	260	390	400	420	660	130	18	63.5	865	100	100	65	222
	22	535	485	260	430	400	460	700	150	18	81.5	895	100	100	65	257
	30	585	505	280	470	450	500	750	150	18	81.5	967	100	100	65	318
	37	585	505	280	470	450	500	750	150	18	81.5	967	100	100	65	337
100-65-250	45	640	555	305	520	500	560	820	160	22	76.5	1042	125	100	65	426
	55	715	600	350	585	550	625	950	200	22	116.5	1156	125	100	65	529
	75	780	630	380	630	600	670	1000	200	22	114	1231	125	100	65	673
100-65-315G	75	780	660	380	630	600	670	1000	200	22	114	1245	125	100	65	693
100-65-315	90	780	660	380	630	600	670	1100	250	22	164	1295	125	100	65	730
	110	945	695	415	720	600	760	1100	250	22	164	1530	125	100	65	1161
100-80-160	11	500	440	240	390	400	420	660	130	18	63.5	810	100	100	80	177
	15	500	440	240	390	400	420	660	130	18	63.5	810	100	100	80	187
	18.5	500	440	240	390	400	420	660	130	18	63.5	865	100	100	80	207
	22	535	460	260	430	400	460	700	150	18	83.5	895	100	100	80	248
125-100-200	30	585	560	280	465	500	495	800	150	18	69	992	125	125	100	349
	37	585	560	280	465	500	495	800	150	18	69	992	125	125	100	368
	45	640	585	305	520	500	560	820	160	22	76.5	1042	125	125	100	431
	55	715	630	350	585	550	625	950	200	22	116.5	1156	125	125	100	534
75	780	660	380	630	600	670	1000	200	22	114	1231	125	125	100	678	

续表

2 极

型号	功率 (kW)	H	H1	H2	HC1	HC2	BW	BL	BP	BH	OH	UL	FC	DN1	DN2	总重量 (kg)
125-100-250	75	780	660	380	630	600	670	1000	200	22	114	1265	140	125	100	701
	90	780	660	380	630	600	670	1100	250	22	164	1315	140	125	100	738
	110	945	695	415	720	600	760	1100	250	22	164	1523	140	125	100	1169
125-100-315	90	780	695	380	630	600	670	1100	250	22	164	1310	140	125	100	744
	110	945	730	415	720	600	760	1100	250	22	164	1545	140	125	100	1170
	132	945	730	415	720	700	760	1220	260	22	174	1655	140	125	100	1230
	160	945	730	415	720	700	760	1220	260	22	174	1655	140	125	100	1350

NIS, NISF泵外形尺寸表

4 极

型号	功率 (kW)	H	H1	H2	HC1	HC2	BW	BL	BP	BH	OH	UL	FC	DN1	DN2	总重量 (kg)
50-32-160	0.55	352	372	212	306	250	336	400	75	14	22.5	483	80	50	32	44
	0.75	352	372	212	306	250	336	400	75	14	22.5	483	80	50	32	45
50-32-200	1.1	400	420	240	306	250	336	400	75	14	22.5	498	80	50	32	71
	1.5	400	420	240	306	250	336	400	75	14	22.5	523	80	50	32	78
65-40-200	1.1	400	420	240	335	250	365	400	75	14	22.5	518	100	65	40	73
	1.5	400	420	240	335	250	365	400	75	14	22.5	543	100	65	40	80
65-40-250	2.2	410	420	240	335	250	365	450	100	14	47.5	583	100	65	40	91
	3	430	485	260	386	300	416	500	100	14	35	591	100	65	40	109
65-40-315	4	468	530	280	415	300	445	500	100	14	35	631	125	65	40	128
	5.5	493	530	280	415	300	445	500	100	14	35	687	125	65	40	151
65-50-160	0.55	352	372	212	306	250	336	400	75	14	22.5	483	80	65	50	46
	0.75	352	372	212	306	250	336	400	75	14	22.5	483	80	65	50	47
	1.1	372	372	212	306	250	336	400	75	14	22.5	498	80	65	50	63
80-50-200	1.5	400	440	240	335	250	365	400	75	14	22.5	543	100	80	50	84
	2.2	410	440	240	335	250	365	450	100	14	47.5	583	100	80	50	95
	3	410	440	240	335	250	365	450	100	14	47.5	583	100	80	50	100
80-50-250	4	448	485	260	386	300	416	500	100	14	35	631	125	80	50	116
	5.5	473	485	260	386	300	416	500	100	14	35	687	125	80	50	137
80-50-315	5.5	518	585	305	415	350	445	550	100	18	33.5	687	125	80	50	155
	7.5	518	585	305	415	350	445	550	100	18	33.5	727	125	80	50	169
80-65-160	0.75	380	420	240	335	250	365	400	75	14	22.5	503	100	80	65	67
	1.1	400	420	240	335	250	365	400	75	14	22.5	518	100	80	65	71
	1.5	400	420	240	335	250	365	400	75	14	22.5	543	100	80	65	78

续表

4 极

型号	功率 (kW)	H	H1	H2	HC1	HC2	BW	BL	BP	BH	OH	UL	FC	DN1	DN2	总重量 (kg)
100-65-200	3	430	485	260	386	300	416	500	100	14	35	591	100	100	65	109
	4	448	485	260	386	300	416	500	100	14	35	606	100	100	65	114
	5.5	473	485	260	386	300	416	500	100	14	35	662	100	100	65	135
100-65-250	5.5	493	530	280	430	350	460	550	100	14	20	687	125	100	65	147
	7.5	493	530	280	430	350	460	550	100	18	20	727	125	100	65	166
100-65-315	11	565	585	305	470	400	500	700	150	18	70	854	125	100	65	249
	15	565	585	305	470	400	500	700	150	18	70	909	125	100	65	270
100-80-160	1.5	400	440	240	350	250	380	410	105	14	40	536	100	100	80	76
	2.2	410	440	240	350	300	380	500	100	14	35	591	100	100	80	87
	3	410	440	240	350	300	380	500	100	14	35	591	100	100	80	92
125-80-400	15	620	715	360	510	450	540	750	150	18	68	911	125	125	80	334
	18.5	635	715	360	510	450	540	750	150	18	66.5	941	125	125	80	369
	22	635	715	360	520	450	560	750	150	22	76.5	981	125	125	80	391
	30	665	715	360	520	500	560	820	160	22	68	1015	125	125	80	440
	37	695	715	360	520	500	560	820	160	22	76.5	1058	125	125	80	498
125-100-200	4	468	560	280	430	300	460	500	100	14	20	631	125	125	100	136
	5.5	493	560	280	430	350	460	550	100	18	20	687	125	125	100	152
	7.5	493	560	280	430	350	460	550	100	18	20	727	125	125	100	171
125-100-250G	11	540	560	280	430	400	460	650	125	18	45	835	125	125	100	222
	15	565	585	305	470	400	500	700	150	18	70	924	140	125	100	258
125-100-250	15	565	585	305	470	400	500	700	150	18	70	924	140	125	100	278
125-100-315G	15	590	645	330	470	400	500	700	150	18	69	869	140	125	100	281
125-100-315	11	590	645	330	470	400	500	700	150	18	69	869	140	125	100	261
	18.5	605	645	330	470	450	500	750	150	18	69	954	140	125	100	317
	22	605	645	330	470	450	500	750	150	18	69	994	140	125	100	335
	30	635	645	330	520	500	560	820	160	22	76.5	1028	140	125	100	394
125-100-400	30	665	715	360	580	500	620	800	150	22	50	1028	140	125	100	444
	37	715	735	380	585	550	625	950	200	22	100	1071	140	125	100	523
150-125-200G	45	715	735	380	585	550	625	950	200	22	100	1101	140	125	100	552
	5.5	543	630	330	470	350	500	570	100	18	20	721	140	150	125	168
150-125-200G	7.5	543	630	330	470	350	500	570	100	18	20	761	140	150	125	180
	11	590	630	330	470	400	500	700	150	18	69	869	140	150	125	235

续表

4极

型号	功率 (kW)	H	H1	H2	HC1	HC2	BW	BL	BP	BH	OH	UL	FC	DN1	DN2	总重量 (kg)
150-125-250	11	590	685	330	470	400	500	700	150	18	69	869	140	150	125	257
	15	590	685	330	470	400	500	700	150	18	69	924	140	150	125	284
	18.5	605	685	330	470	450	500	750	150	18	69	954	140	150	125	315
	22	605	685	330	470	450	500	750	150	18	69	994	140	150	125	333
150-125-315	30	665	715	360	580	500	620	800	150	22	50	1028	140	150	125	430
	37	715	735	380	585	550	625	950	200	22	100	1071	140	150	125	507
150-125-400	45	750	815	415	585	550	625	950	200	22	100	1103	140	150	125	561
	55	780	815	415	585	550	625	950	200	22	100	1187	140	150	125	620
	75	815	815	415	630	600	670	1000	200	22	100	1262	140	150	125	776
200-150-250G	15	620	735	360	580	500	620	800	150	22	50	956	160	200	150	299
	18.5	635	735	360	580	500	620	800	150	22	50	988	160	200	150	337
	22	635	735	360	580	500	620	800	150	22	50	1026	160	200	150	360
	30	665	735	360	580	500	620	800	150	22	50	1048	160	200	150	426
200-150-315	37	750	815	415	605	500	670	900	200	22	100	1116	160	200	150	541
	45	750	815	415	605	500	645	900	200	22	100	1146	160	200	150	579
	55	780	815	415	605	600	645	1000	200	22	100	1254	160	200	150	650
	75	815	815	415	630	600	675	1100	250	22	150	1329	160	200	150	806
200-150-400	75	815	865	415	630	600	675	1100	250	22	150	1329	160	200	150	859
	90	815	865	415	630	600	675	1100	250	22	150	1379	160	200	150	956
	110	945	865	415	720	700	760	1220	260	22	160	1614	160	200	150	1325
250-200-315	37	750	865	415	605	500	670	900	200	22	100	1136	180	250	200	592
	45	750	865	415	605	500	645	900	200	22	100	1166	180	250	200	630
	55	780	865	415	605	600	645	1100	250	22	150	1274	180	250	200	695
	75	815	865	415	630	600	675	1100	250	22	150	1349	180	250	200	840
250-200-400	90	845	930	480	630	600	675	1100	250	22	150	1399	180	250	200	1015
	110	1010	930	480	720	750	760	1250	250	22	150	1634	180	250	200	1400
	132	1010	930	480	720	700	760	1220	260	22	160	1744	180	250	200	1495
	160	1010	930	480	720	700	760	1220	260	22	160	1744	180	250	200	1564
300-250-315(Q)	75	930	930	475	810	750	850	1250	250	22	90	1356	225	300	250	1120
	90	930	930	475	810	750	850	1250	250	22	90	1406	225	300	250	1182
	110	1005	930	475	810	750	850	1250	250	22	90	1743	225	300	250	1518
300-250-400(Q)	110	1055	1025	525	810	750	850	1250	250	22	90	1611	225	300	250	1582
	132	1055	1025	525	810	900	850	1400	250	22	90	1721	225	300	250	1676
	160	1055	1025	525	810	900	850	1400	250	22	90	1721	225	300	250	1777
	200	1055	1025	525	810	900	850	1400	250	22	90	1721	225	300	250	1853

续表

4极

型号	功率 (kW)	H	H1	H2	HC1	HC2	BW	BL	BP	BH	OH	UL	FC	DN1	DN2	总重量 (kg)
300-250-315	75	930	930	475	810	750	850	1250	250	22	90	1356	225	300	250	1120
	90	930	930	475	810	750	850	1250	250	22	90	1406	225	300	250	1182
	110	1005	930	475	810	750	850	1250	250	22	90	1743	225	300	250	1518
	132	1055	1025	525	810	900	850	1400	250	22	90	1721	225	300	250	1676
300-250-400	160	1055	1025	525	810	900	850	1400	250	22	90	1721	225	300	250	1777
	200	1055	1025	525	810	900	850	1400	250	22	90	1721	225	300	250	1853

NIS, NISF法兰

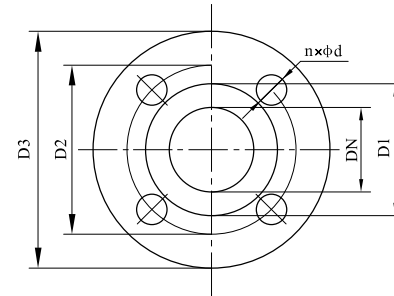

NIS, NISF 法兰尺寸

DN	D1	D2	D3	n	d
32	78	100	140	4	18
50	102	125	165	4	18
65	122	145	185	4	18
80	133	160	200	8	18
100	158	180	220	8	18
125	184	210	250	8	18
150	212	240	285	8	22
200	268	295	340	12	22
250	320	355	405	12	26
300	370	410	460	12	27

### 型号含义

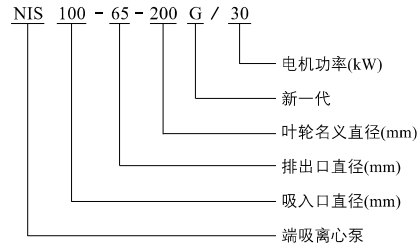

### 最小进口压力

最小进口压力取决于NPSH值+0.5m的安全余量+汽化压力。如果下列情况发生，重新计算进口压力：

- 液体温度较高
- 流量超过最大允许使用值时
- 吸程较大或进口管路较长
- 系统压力太小
- 进口条件差、系统进口压力低

### 典型应用

● 产品适宜在清洁、稀薄、非侵蚀、非易燃易爆且不含固体颗粒或纤维的液体中使用。

- 供水系统
- 供热、空调系统
- 增压供水、恒压供水
- 消防喷淋系统
- 灌溉、畜牧使用
- 工业冷却、加热循环系统
- 工业输送、排放系统

### 泵结构

● 泵为非自吸、单级单吸卧式，轴向进水，径向出水，泵体底部与底座固定。

- 采用标准型耐磨机械密封。
- 全封闭、风冷IEC标准电机。
- 采用直联型联接加长轴结构。
- 进出口法兰符合GB/T17241.6(ISO7005-2)标准，压力等级PN16。

### 性能参数

- 最大流量：480m<sup>3</sup>/h
- 最高扬程：160m
- 最大工作压力：16bar
- 最大进口压力：6bar
- 最大功率：160kW
- 介质温度：-15°C~110°C
- 进出口径：进口口径：DN100-DN200  
出口口径：DN65-DN150

### 曲线条件

下列说明适用于后面所示的曲线。

- 曲线容差符合ISO9906:2012,3B。
- 所有曲线都基于电机在恒速2950rpm、1450rpm或1480rpm的测试值。
- 测试采用20°C不含空气的水，运动粘度为1mm<sup>2</sup>/s。

### 特点

- 采用后拉式结构，维修时无须拆除泵体及管路。
- 本系列产品完全按照GB/T5662最新标准设计，采用优秀水力模型、CFD优化，效率高，扬程分布合理。结构紧凑，安装方便。

### 备注

- 本系列截面图同NIS,NISF截面图，见P7。
- 泵叶轮、泵体、泵盖等主要零部件材料为铸铁。如有特殊要求，可根据用户需要定制。
- 本系列外形尺寸图同NIS,NISF外形尺寸图，见P45。
- 本系列外形尺寸同NIS,NISF对应规格外形尺寸，见P45 NIS,NISF外形尺寸表。

### 型谱图

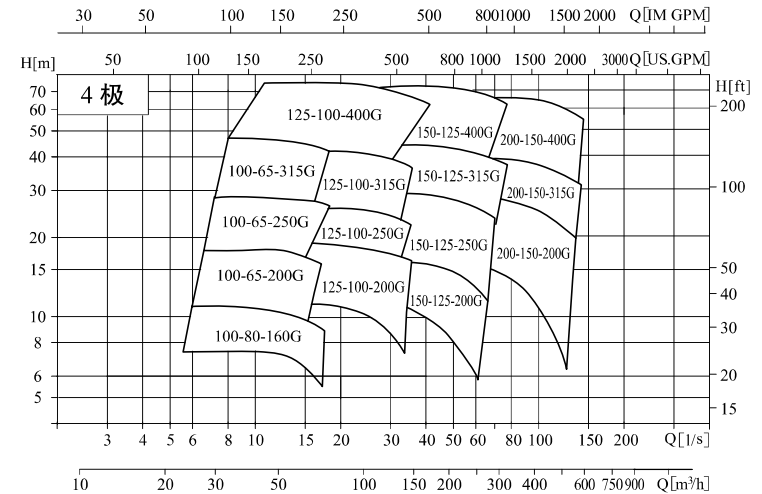
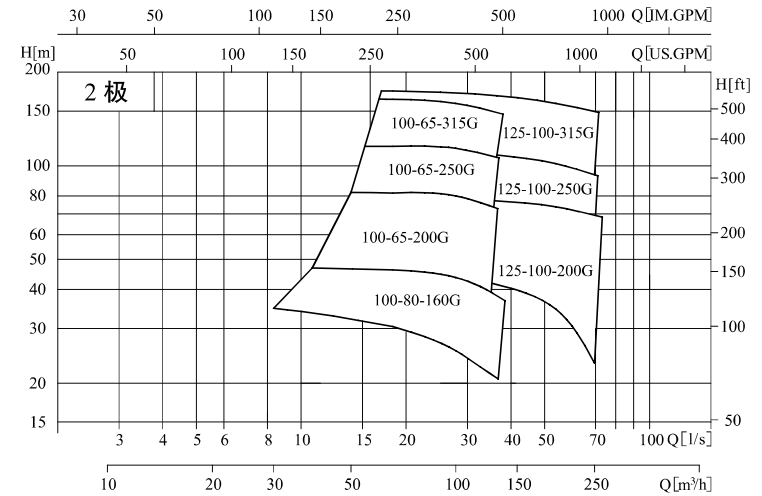

产品范围

序号	泵型号	Q [m³/h]	H [m]	流量使用范围 [m³/h]	配用电机 [kW]	n [r/min]
1	NIS100-65-200G/18.5	100	42	40~120	18.5	2950
2	NIS100-65-200G/22		51			
3	NIS100-65-200G/30		67			
4	NIS100-65-200G/37		80			
5	NIS100-65-250G/45		103			
6	NIS100-65-250G/55		116			
7	NIS100-65-315G/75		140			
8	NIS100-65-315G/90		160			
9	NIS100-80-160G/11		26			
10	NIS100-80-160G/15		36			
11	NIS100-80-160G/18.5		44			
12	NIS125-100-200G/30	200	35	80~240	30	2950
13	NIS125-100-200G/37		45			
14	NIS125-100-200G/45		54			
15	NIS125-100-200G/55		68			
16	NIS125-100-200G/75		74			
17	NIS125-100-250G/75		86			
18	NIS125-100-250G/90		102			
19	NIS125-100-315G/110		128			
20	NIS125-100-315G/132		150			
21	NIS125-100-315G/160		160			
22	NIS100-65-200G/3		50		13	
23	NIS100-65-200G/4	17.5		4		
24	NIS100-65-250G/5.5	24		5.5		
25	NIS100-65-250G/7.5	28		7.5		
26	NIS100-65-315G/11	40		11	1480	
27	NIS100-65-315G/15	45		15		
28	NIS100-80-160G/1.5	7		1.5		
29	NIS100-80-160G/2.2	10		2.2	1450	

产品范围

序号	泵型号	Q [m³/h]	H [m]	流量使用范围 [m³/h]	配用电机 [kW]	n [r/min]		
30	NIS125-100-200G/4	100	9.5	40~120	4	1450		
31	NIS125-100-200G/5.5		13		5.5			
32	NIS125-100-200G/7.5		18		7.5			
33	NIS125-100-250G/11		25		11	1480		
34	NIS125-100-315G/15		33		15			
35	NIS125-100-315G/18.5		40		18.5			
36	NIS125-100-400G/30		55		30			
37	NIS125-100-400G/37		68		37			
38	NIS125-100-400G/45		72		45			
39	NIS150-125-200G/5.5		200		7	80~240	5.5	1450
40	NIS150-125-200G/7.5				10		7.5	
41	NIS150-125-200G/11	14		11				
42	NIS150-125-250G/15	18		15	1480			
43	NIS150-125-250G/18.5	23		18.5				
44	NIS150-125-250G/22	27		22				
45	NIS150-125-315G/30	36		30				
46	NIS150-125-315G/37	42		37				
47	NIS150-125-400G/45	54		45				
48	NIS150-125-400G/55	64		55				
49	NIS150-125-400G/75	71		75				
50	NIS200-150-250G/15	400	9	160~480	15	1480		
51	NIS200-150-250G/18.5		12		18.5			
52	NIS200-150-250G/22		15.5		22			
53	NIS200-150-250G/30		20		30			
54	NIS200-150-315G/37		24		37			
55	NIS200-150-315G/45		29		45			
56	NIS200-150-315G/55		36		55			
57	NIS200-150-400G/75		47		75			
58	NIS200-150-400G/90		56		90			
59	NIS200-150-400G/110		63		110			



NIS100-65-200G

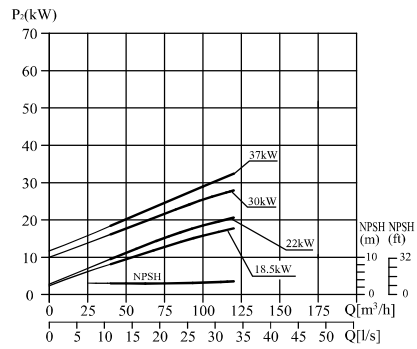
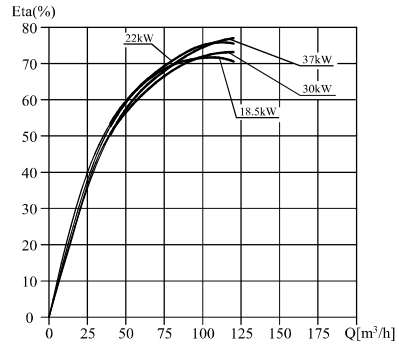
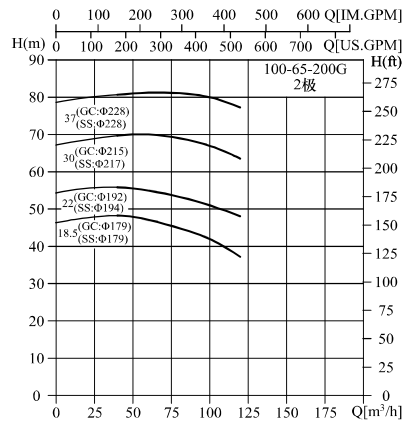

NIS100-65-250G

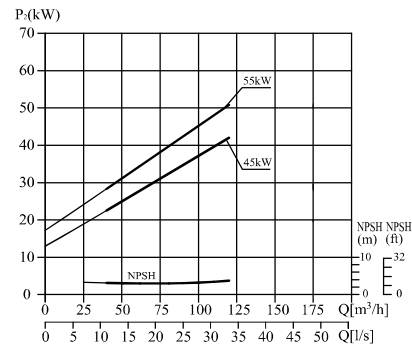
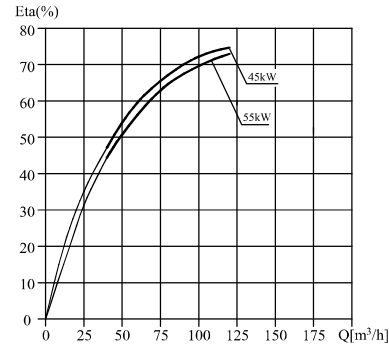
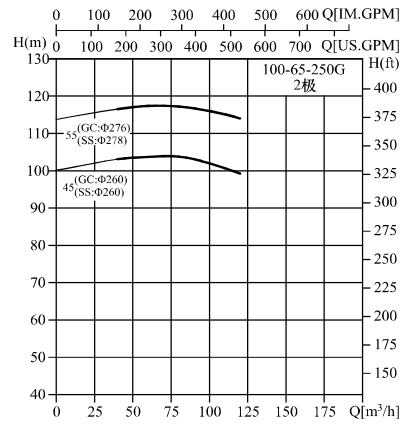

NIS100-65-315G

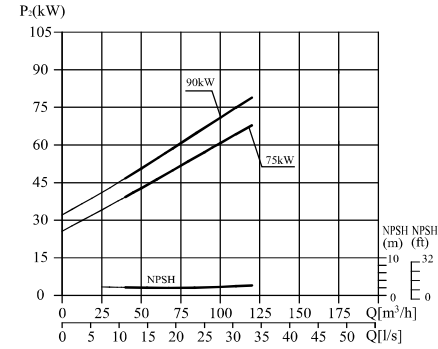
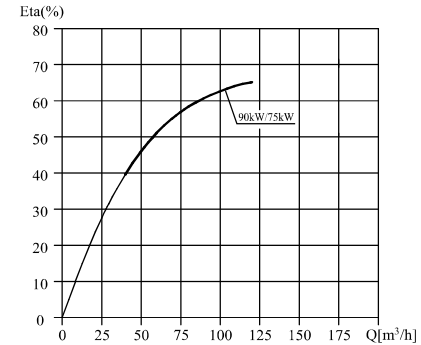
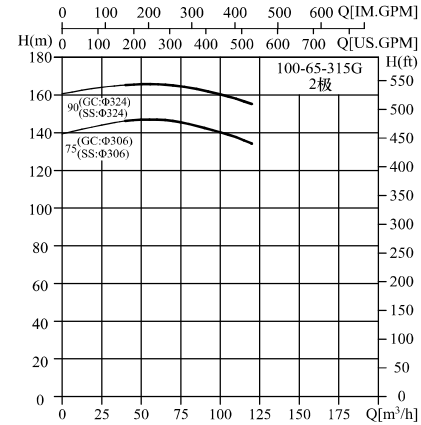

NIS100-80-160G

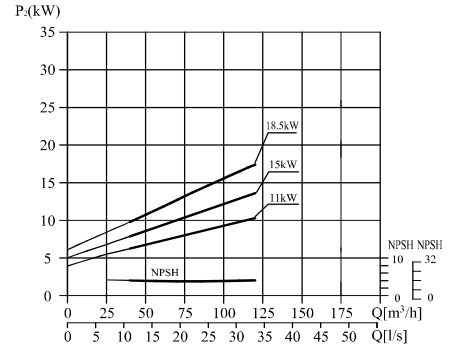
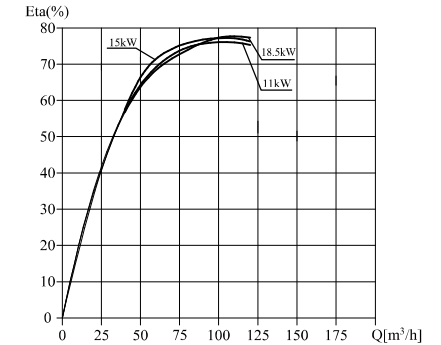
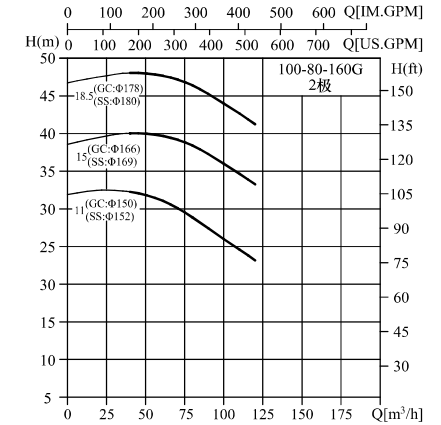

NIS125-100-200G

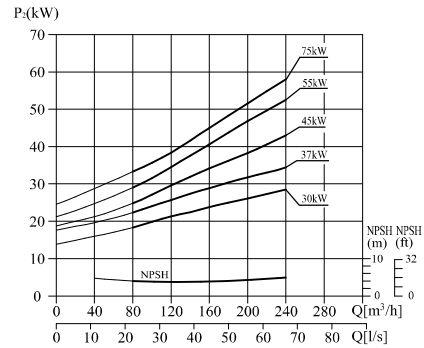
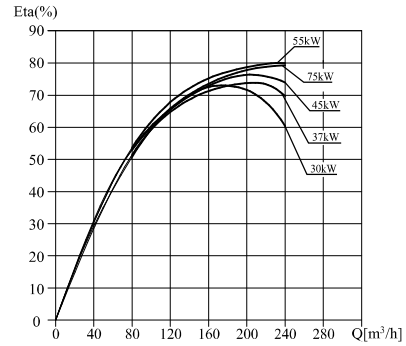
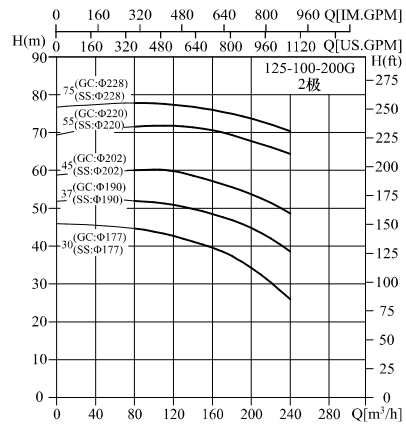

NIS125-100-250G

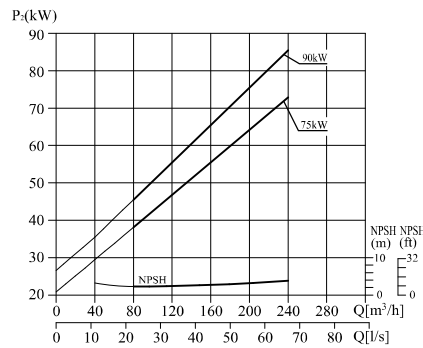
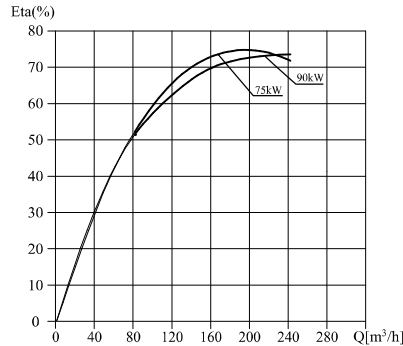
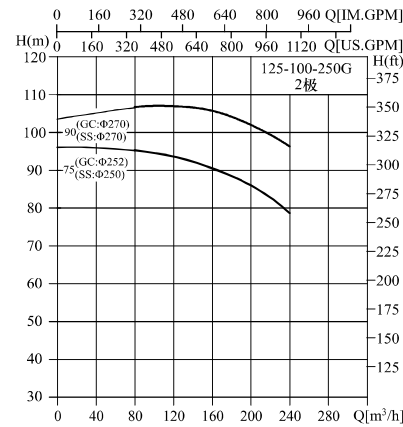

NIS125-100-315G

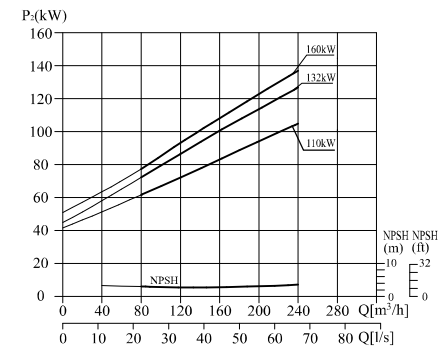
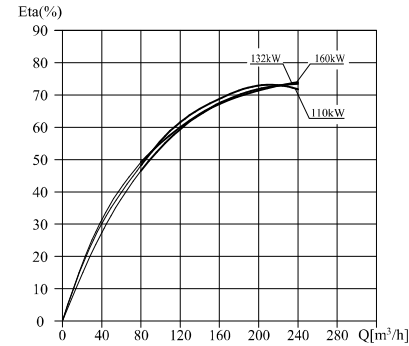
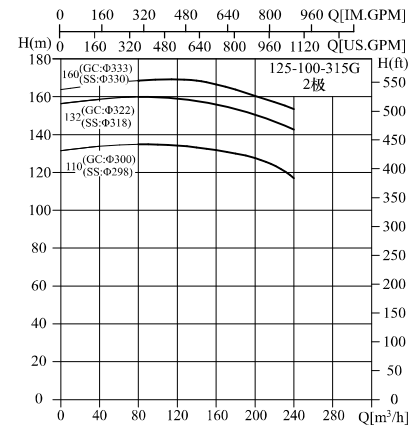

NIS100-65-200G

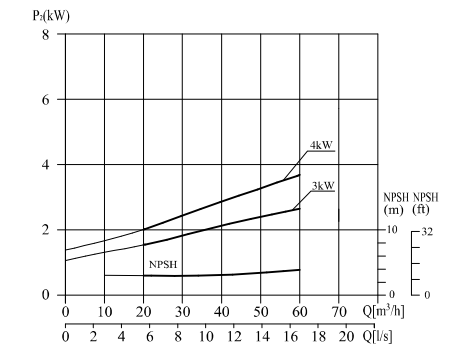
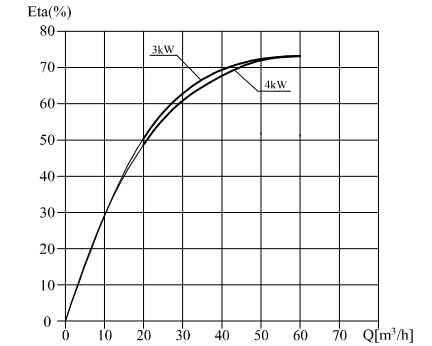
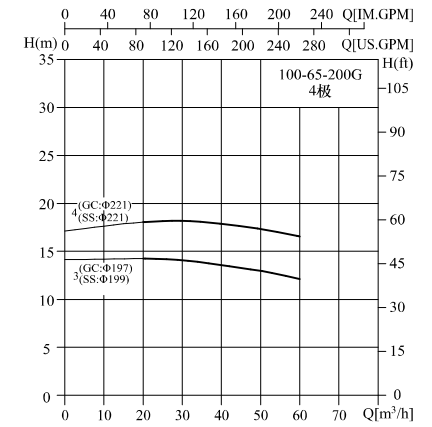

NIS100-65-250G

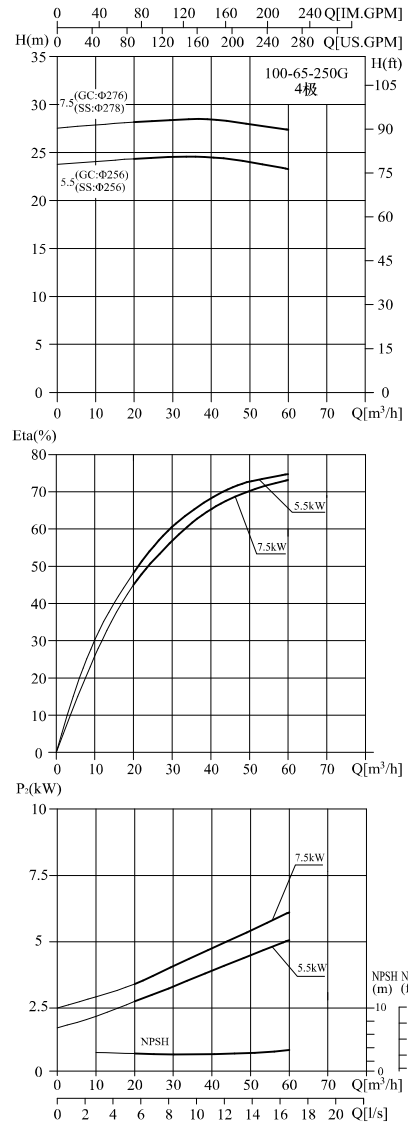

NIS100-65-315G

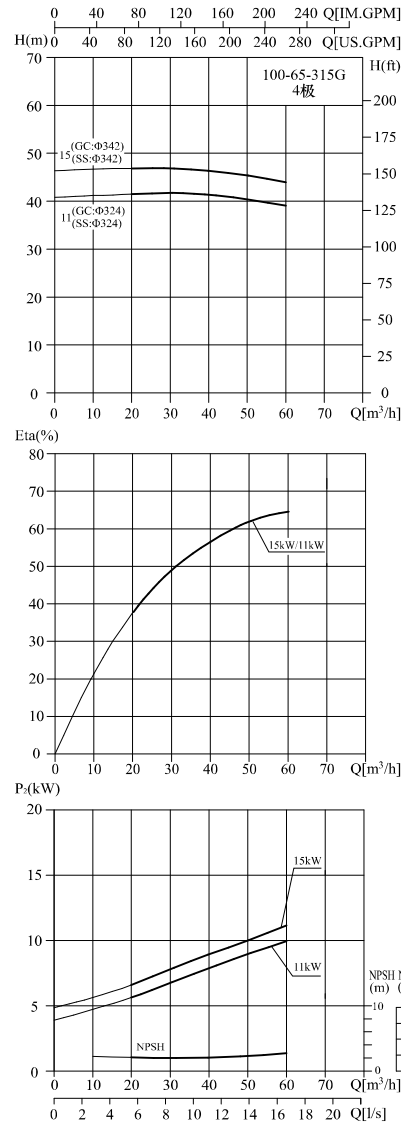

NIS100-80-160G

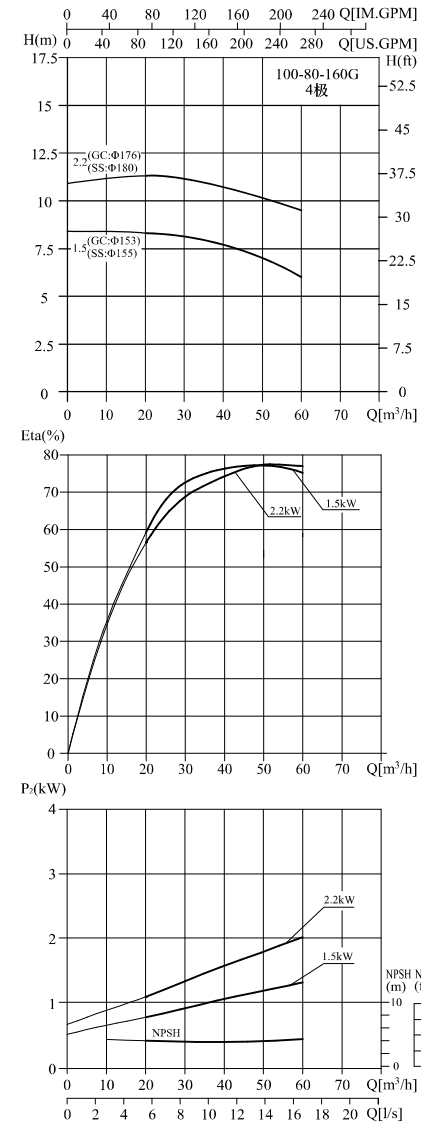

NIS125-100-200G

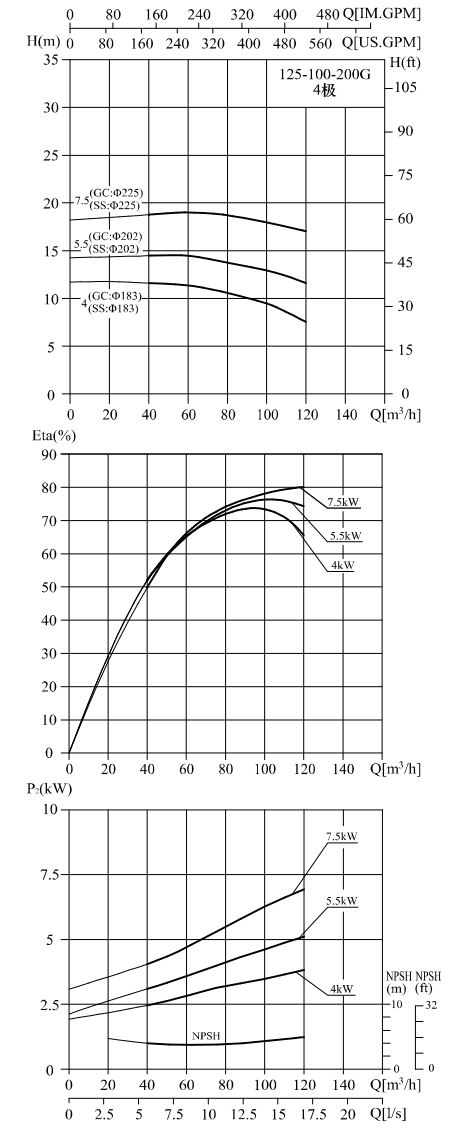

NIS125-100-250G

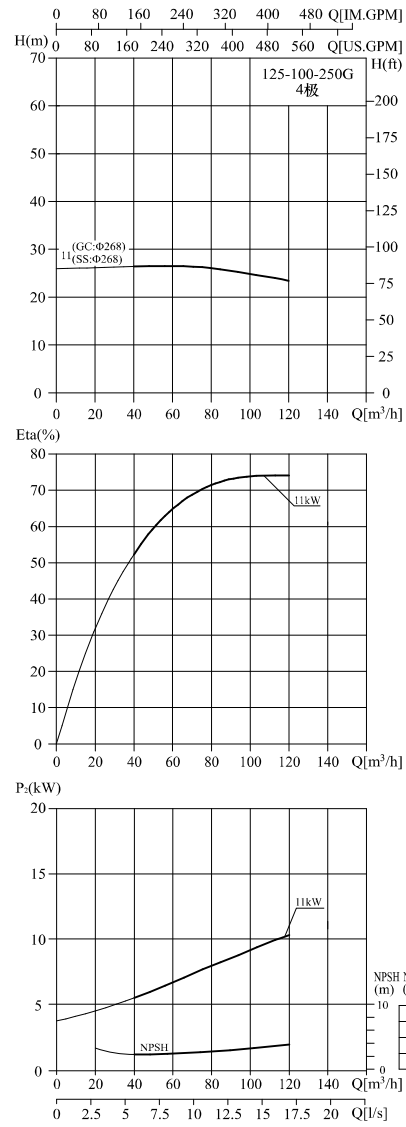

NIS125-100-315G

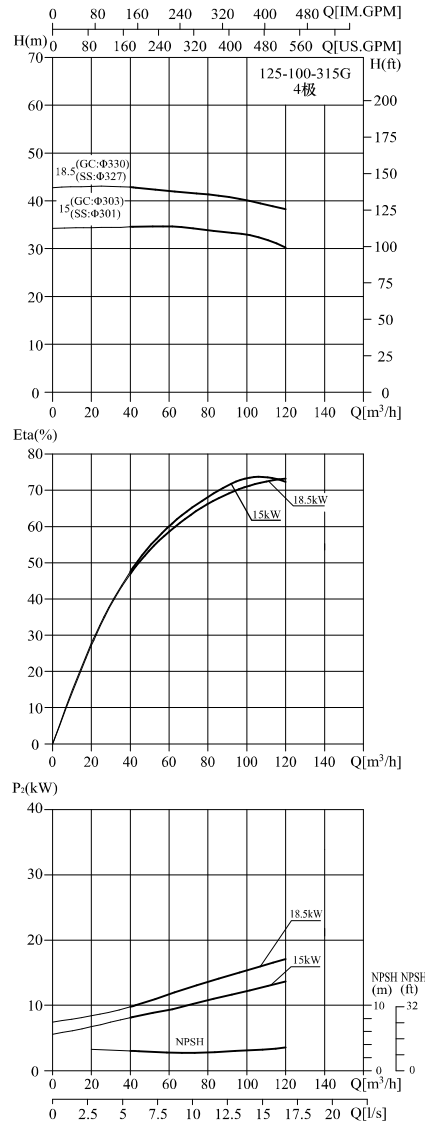

NIS125-100-400G

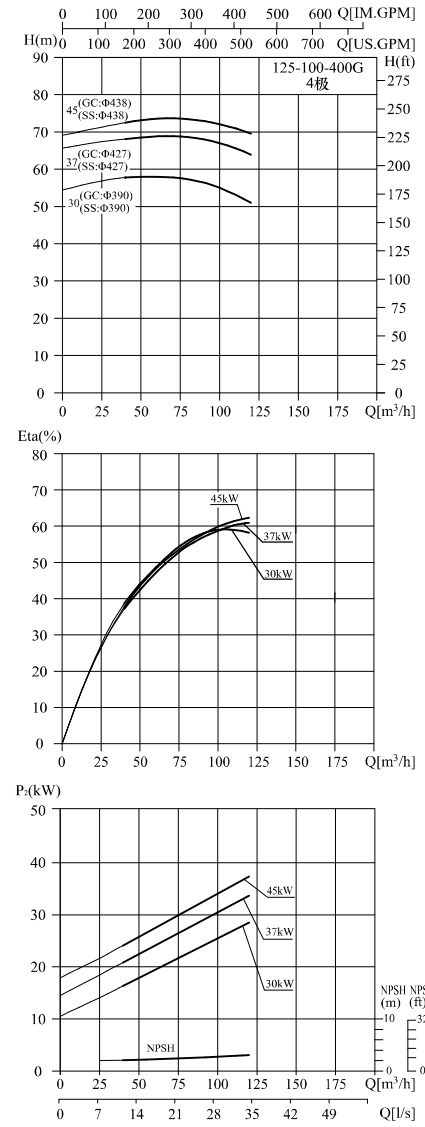

NIS150-125-200G

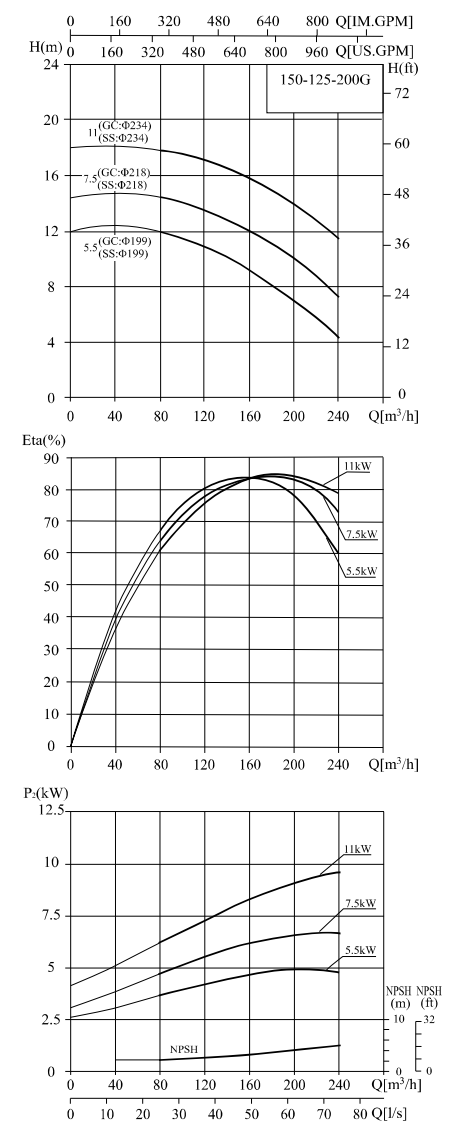

NIS150-125-250G

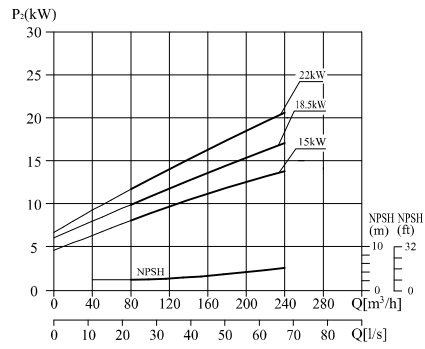
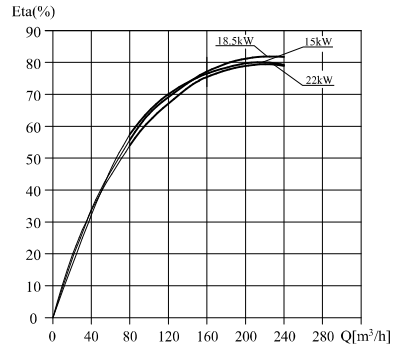
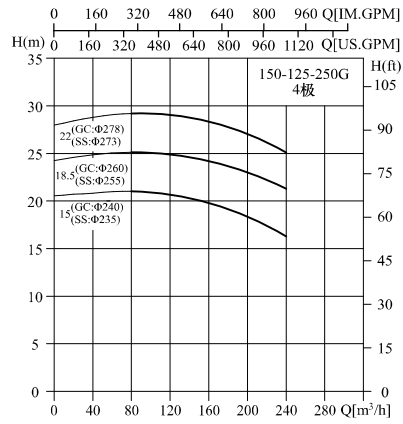

NIS150-125-315G

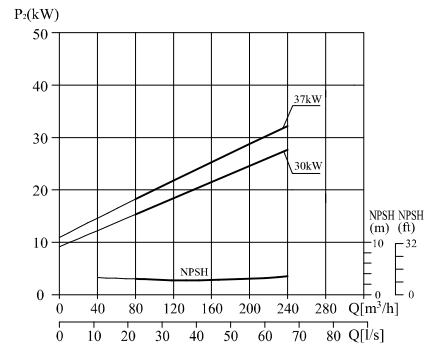
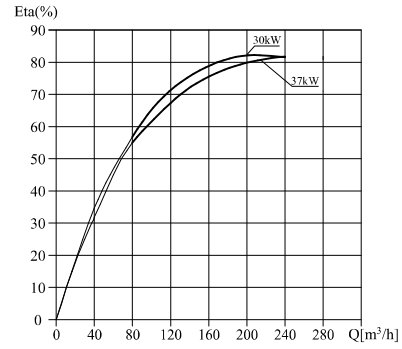
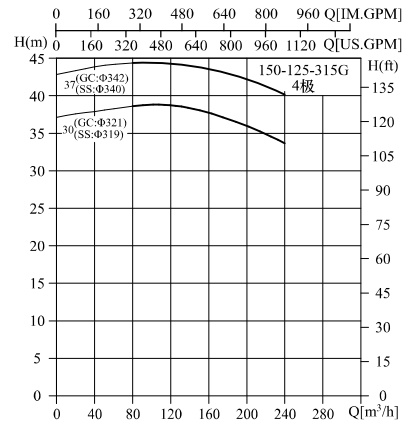

NIS150-125-400G

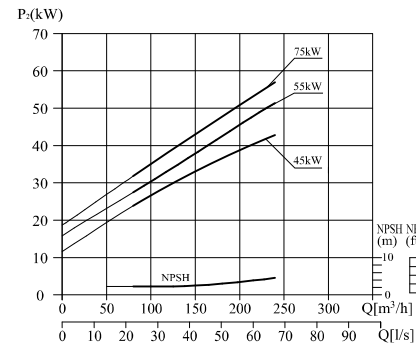
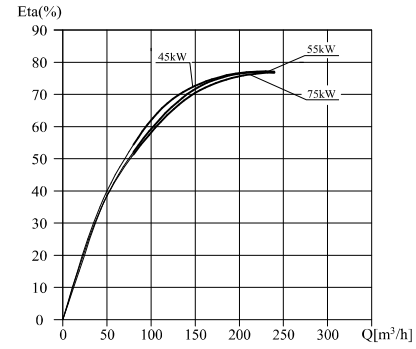
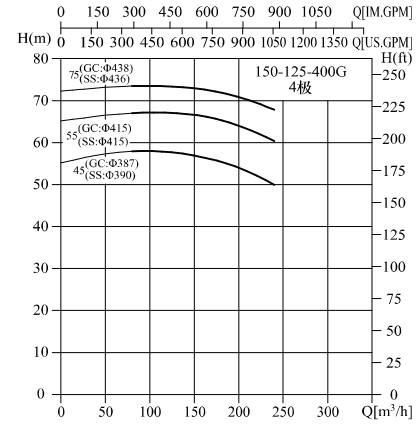

NIS200-150-250G

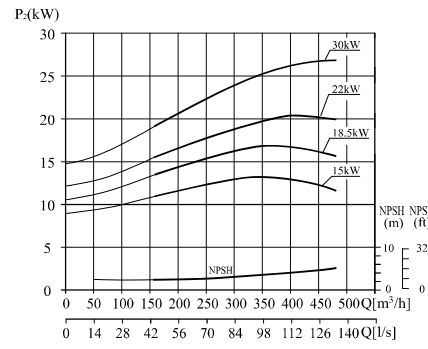
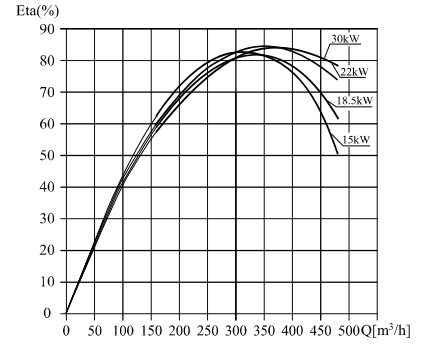
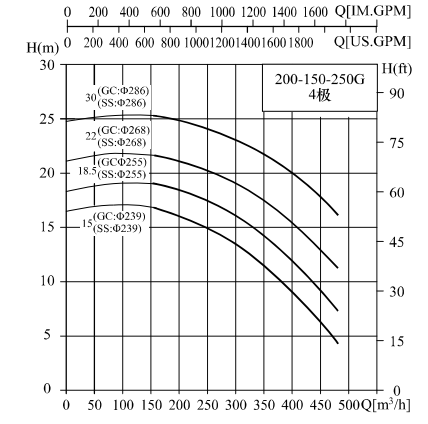

NIS200-150-315G

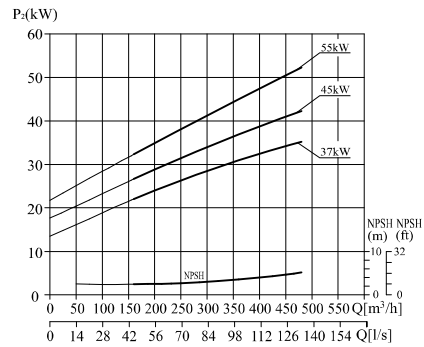
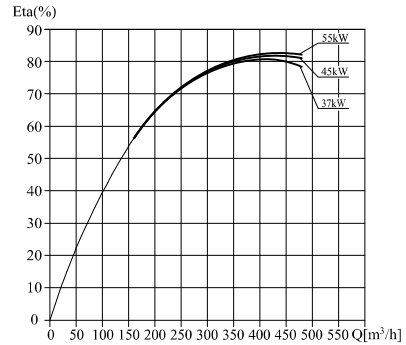
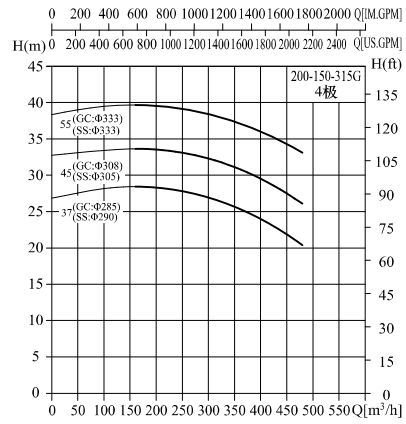

NIS200-150-400G

